

Technical Datasheet

BERNATI

BMT Series - Aluminum frame three phase low voltage electric motor

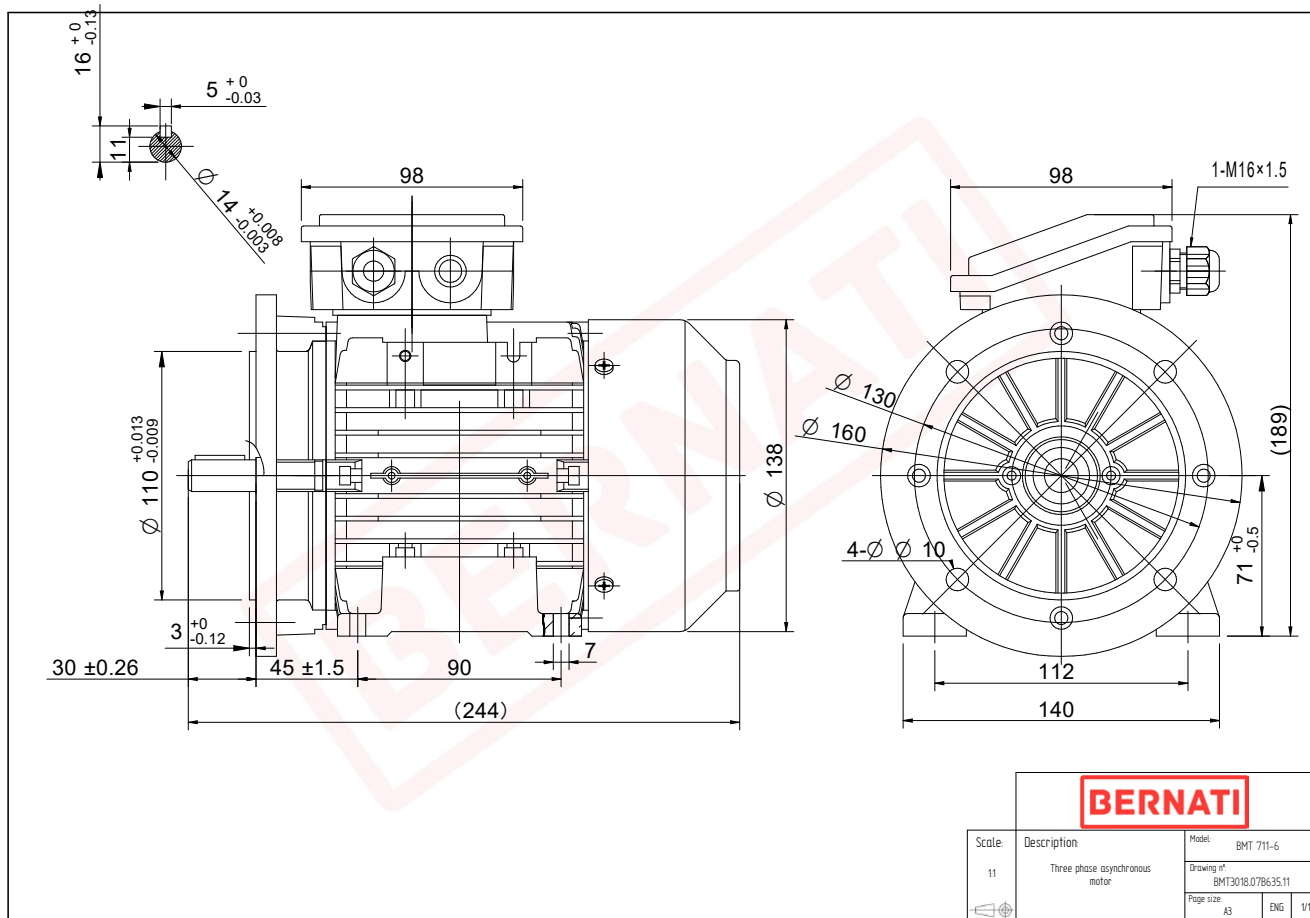

BMT

Product Code	BMT3018.07B635.11
Motor Type/Frame	BMT 711-6
Mounting	IM B3/B5
Efficiency Class	IE3
Output Power (kW)	0.18
Speed (rpm)	930
Tension (V)	230/400
Frequency (Hz)	50
Current (A)	0.66
Power factor (Cos Ø)	0.62
Poles	6
Insulation Class	F
IP Class	IP55
50% Efficiency	53.4
75% Efficiency	61.0
100% Efficiency	63.9
Torque (Nm)	1.85
Tstart / Tnominal	2.40
Istart / Inominal	3.50
Tmax / Tnominal	2.60
Noise (dB)	52
PTC Thermistor	PTC 130
Weight (Kg)	5
DE Bearing	6202 2RZ C3
NDE Bearing	6202 2RZ C3