

Technical Datasheet

BERNATI

BCT Series - Cast iron frame three phase low voltage electric motor

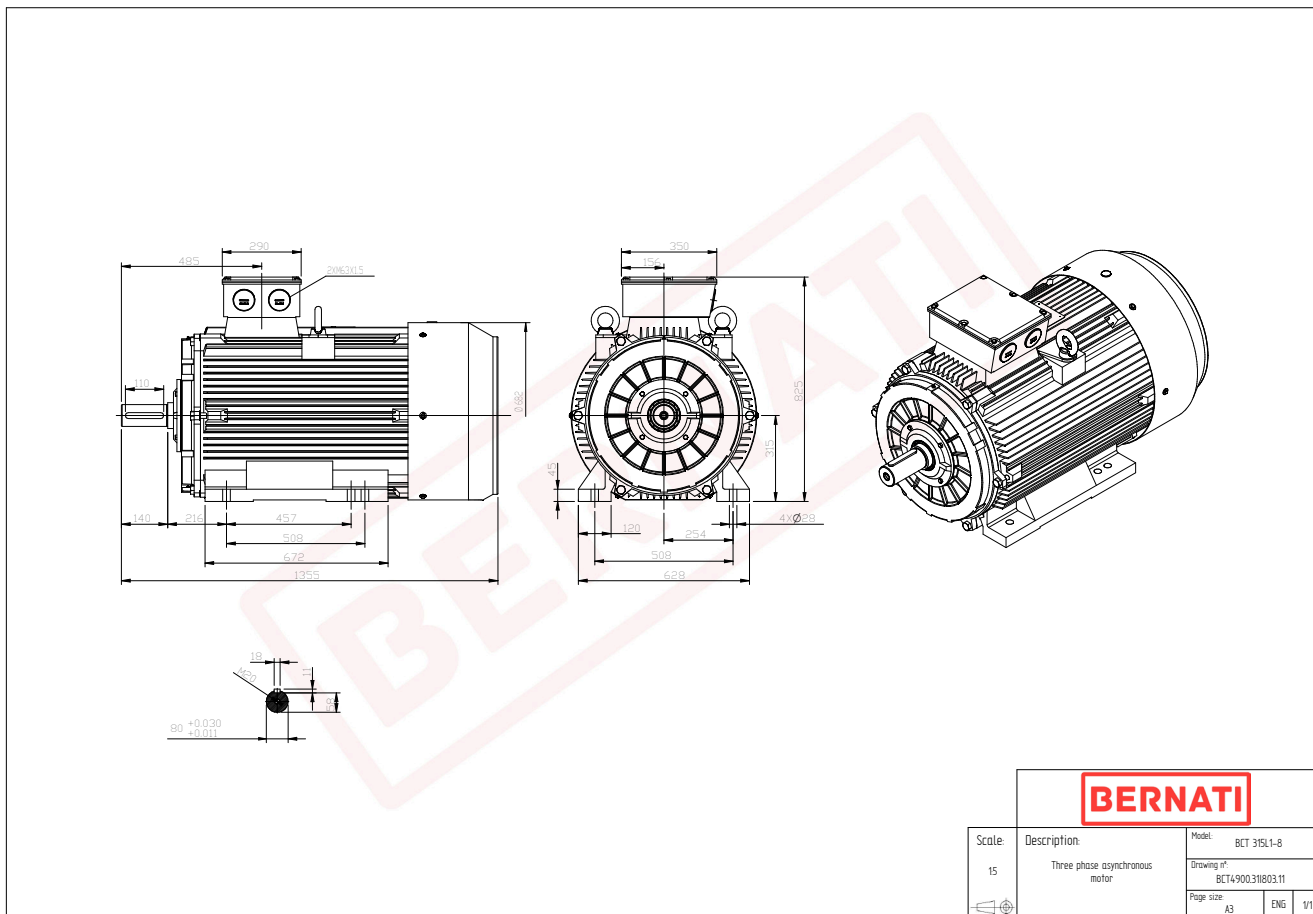

BCT

Product Code	BCT4900.31803.11
Motor Type/Frame	BCT 315L1-8
Mounting	IM B3
Efficiency Class	IE4
Output Power (kW)	90.00
Speed (rpm)	740
Tension (V)	230/400
Frequency (Hz)	50
Current (A)	169.90
Power factor (Cos Ø)	0.80
Poles	8
Insulation Class	F
IP Class	IP55
50% Efficiency	94.2
75% Efficiency	94.6
100% Efficiency	94.4
Torque (Nm)	1162.00
Tstart / Tnominal	1.60
Istart / Inominal	7.70
Tmax / Tnominal	2.00
Noise (dB)	82
PTC Thermistor	PTC 130
Weight (Kg)	1158
DE Bearing	NU319
NDE Bearing	6319 C3