

BCT Series - Cast iron frame three phase low voltage electric motor

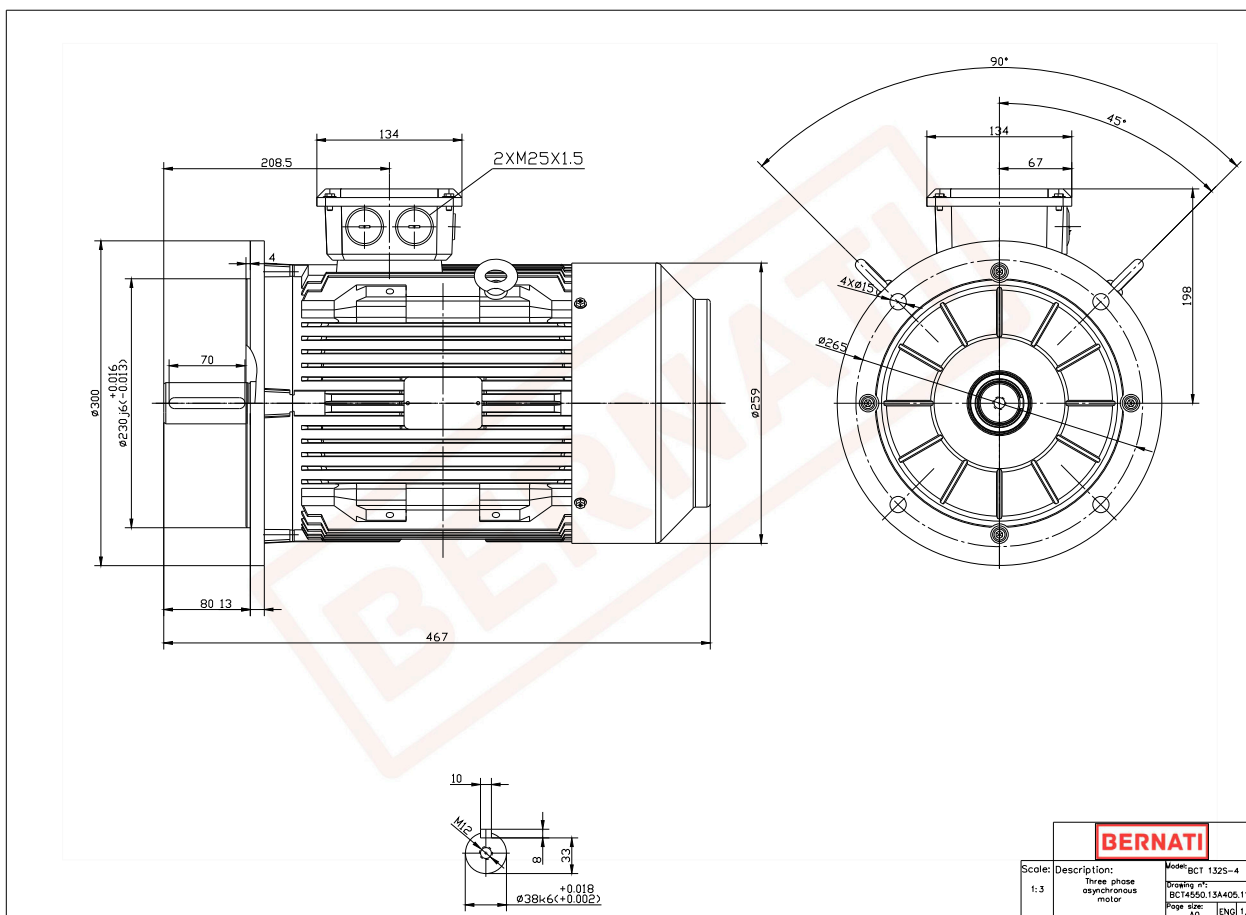

BCT

Product Code	BCT4550.13A405.11
Motor Type/Frame	BCT 132S-4
Mounting	IM B5
Efficiency Class	IE4
Output Power (kW)	5.50
Speed (rpm)	1470
Tension (V)	230/400
Frequency (Hz)	50
Current (A)	10.80
Power factor (Cos ϕ)	0.80
Poles	4
Insulation Class	F
IP Class	IP55
50% Efficiency	91.5
75% Efficiency	92.1
100% Efficiency	91.9
Torque (Nm)	35.80
T _{start} / T _{nominal}	2.00
I _{start} / I _{nominal}	9.50
T _{max} / T _{nominal}	2.30
Noise (dB)	71
PTC Thermistor	PTC 130
Weight (Kg)	75
DE Bearing	6308 2RZ C3
NDE Bearing	6308 2RZ C3