

Technical Datasheet

BERNATI

BCT Series - Cast iron frame three phase low voltage electric motor

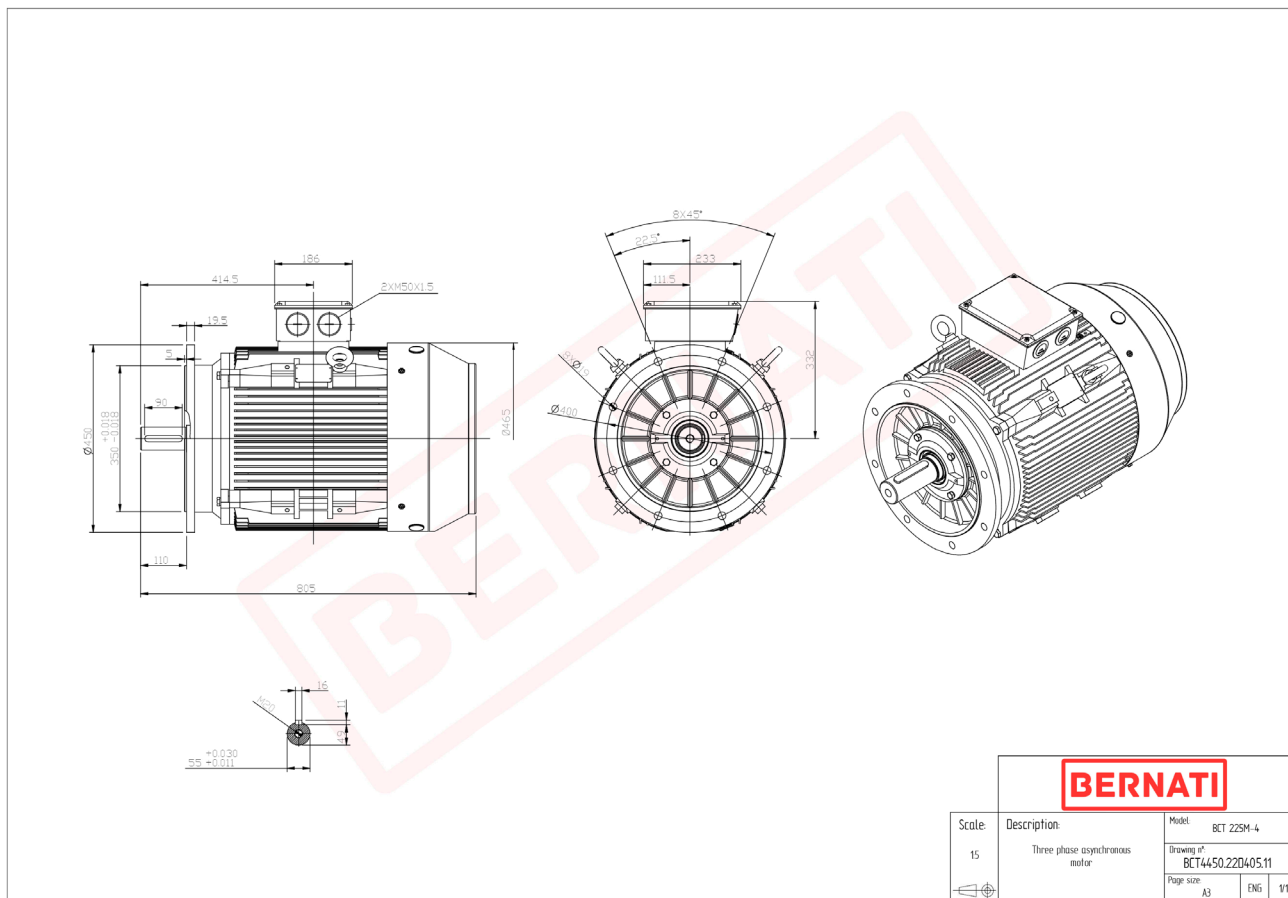

BCT

| | |
|----------------------|-------------------|
| Product Code | BCT4450.22D405.11 |
| Motor Type/Frame | BCT 225M-4 |
| Mounting | IM B5 |
| Efficiency Class | IE4 |
| Output Power (kW) | 45.00 |
| Speed (rpm) | 1480 |
| Tension (V) | 230/400 |
| Frequency (Hz) | 50 |
| Current (A) | 80.10 |
| Power factor (Cos Ø) | 0.90 |
| Poles | 4 |
| Insulation Class | F |
| IP Class | IP55 |
| 50% Efficiency | 95.0 |
| 75% Efficiency | 95.6 |
| 100% Efficiency | 95.4 |
| Torque (Nm) | 290.50 |
| Tstart / Tnominal | 2.00 |
| Istart / Inominal | 9.00 |
| Tmax / Tnominal | 2.30 |
| Noise (dB) | 78 |
| PTC Thermistor | PTC 130 |
| Weight (Kg) | 425 |
| DE Bearing | 6313 C3 |
| NDE Bearing | 6313 C3 |