

BCT Series - Cast iron frame three phase low voltage electric motor

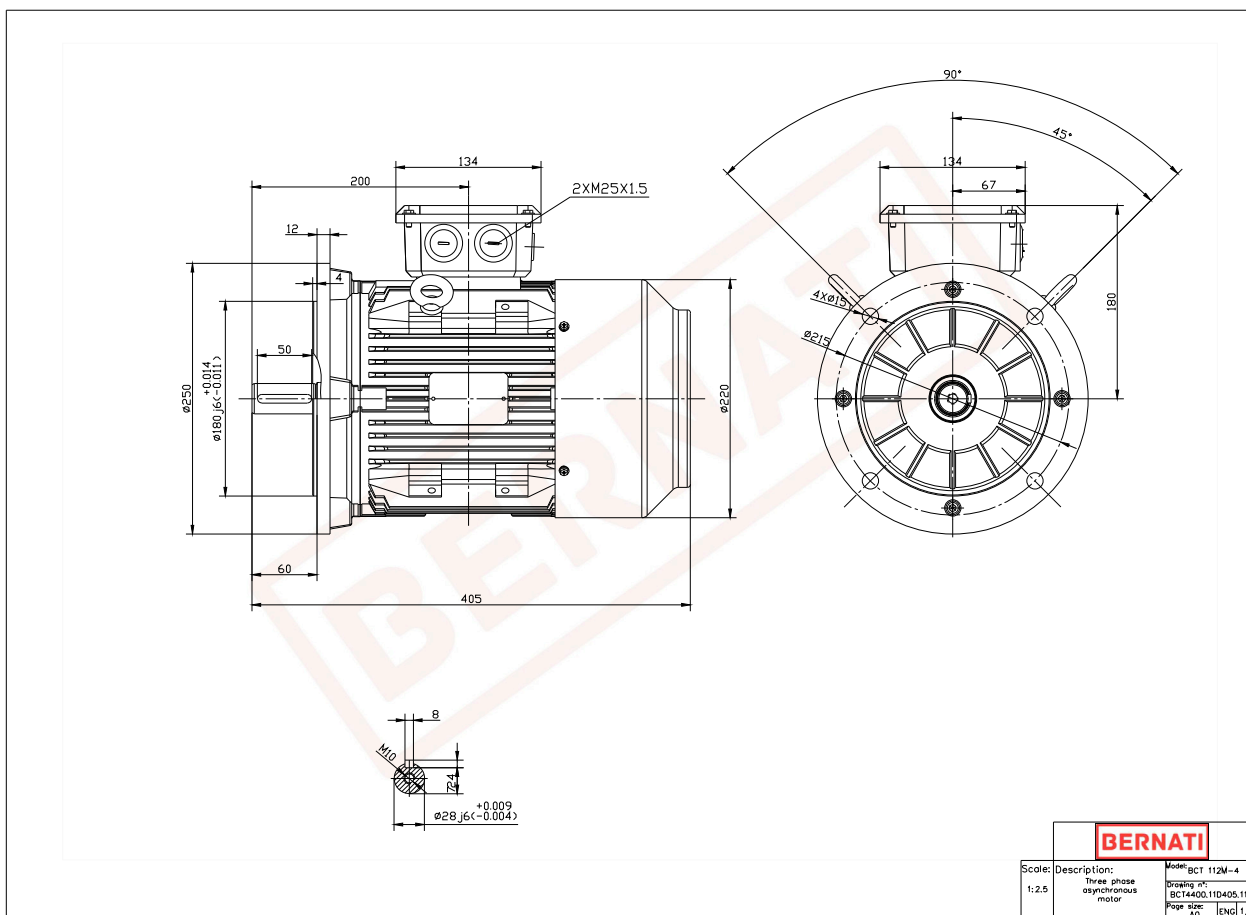

BCT

Product Code	BCT4400.11D405.11
Motor Type/Frame	BCT 112M-4
Mounting	IM B5
Efficiency Class	IE4
Output Power (kW)	4.00
Speed (rpm)	1465
Tension (V)	230/400
Frequency (Hz)	50
Current (A)	7.90
Power factor (Cos Ø)	0.80
Poles	4
Insulation Class	F
IP Class	IP55
50% Efficiency	90.9
75% Efficiency	91.3
100% Efficiency	91.1
Torque (Nm)	26.10
Tstart / Tnominal	2.30
Istart / Inominal	9.50
Tmax / Tnominal	2.30
Noise (dB)	65
PTC Thermistor	PTC 130
Weight (Kg)	61
DE Bearing	6306 2RZ C3
NDE Bearing	6306 2RZ C3