

Technical Datasheet

BERNATI

BCT Series - Cast iron frame three phase low voltage electric motor

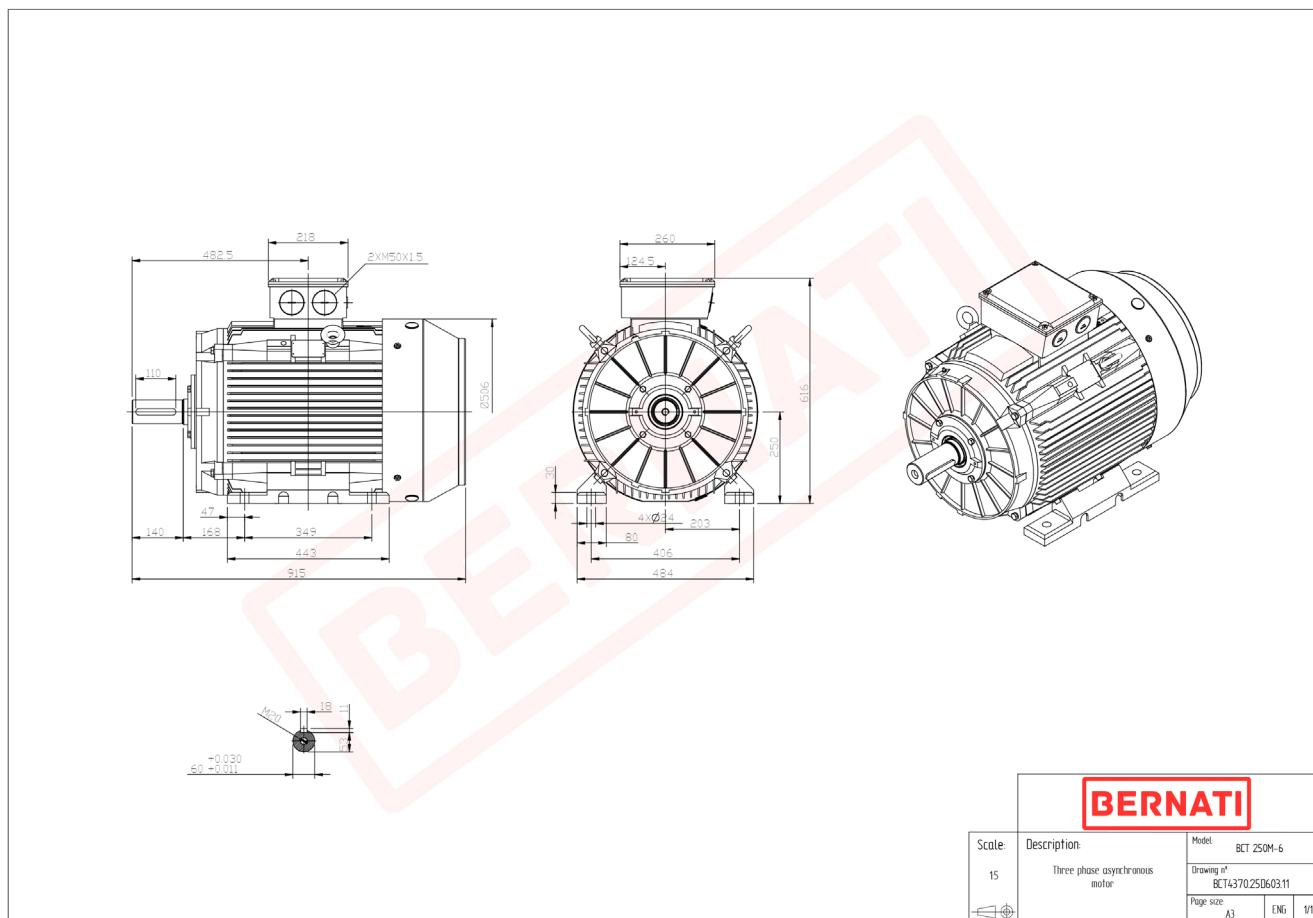

BCT

Product Code	BCT4370.25D603.11
Motor Type/Frame	BCT 250M-6
Mounting	IM B3
Efficiency Class	IE4
Output Power (kW)	37.00
Speed (rpm)	980
Tension (V)	230/400
Frequency (Hz)	50
Current (A)	68.10
Power factor (Cos Ø)	0.80
Poles	6
Insulation Class	F
IP Class	IP55
50% Efficiency	94.3
75% Efficiency	94.7
100% Efficiency	94.5
Torque (Nm)	360.70
Tstart / Tnominal	2.00
Istart / Inominal	8.30
Tmax / Tnominal	2.10
Noise (dB)	76
PTC Thermistor	PTC 130
Weight (Kg)	430
DE Bearing	6314 C3
NDE Bearing	6314 C3