

BCT Series - Cast iron frame three phase low voltage electric motor

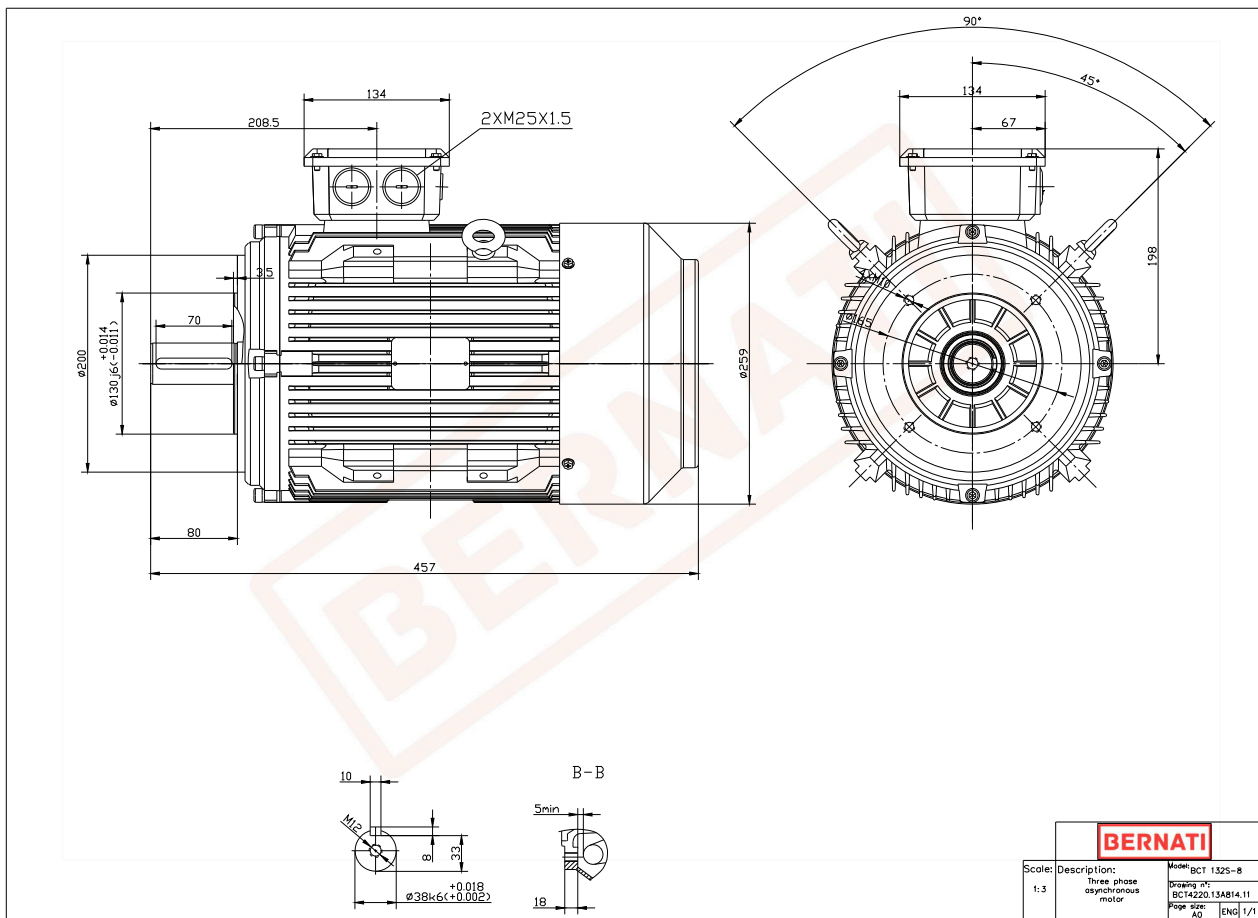

BCT

Product Code	BCT4220.13A814.11
Motor Type/Frame	BCT 132S-8
Mounting	IM B14
Efficiency Class	IE4
Output Power (kW)	2.20
Speed (rpm)	715
Tension (V)	230/400
Frequency (Hz)	50
Current (A)	5.40
Power factor (Cos ϕ)	0.70
Poles	8
Insulation Class	F
IP Class	IP55
50% Efficiency	84.3
75% Efficiency	84.7
100% Efficiency	84.5
Torque (Nm)	29.40
T _{start} / T _{nominal}	1.80
I _{start} / I _{nominal}	7.50
T _{max} / T _{nominal}	2.00
Noise (dB)	64
PTC Thermistor	PTC 130
Weight (Kg)	56
DE Bearing	6308 2RZ C3
NDE Bearing	6308 2RZ C3