

BCT Series - Cast iron frame three phase low voltage electric motor

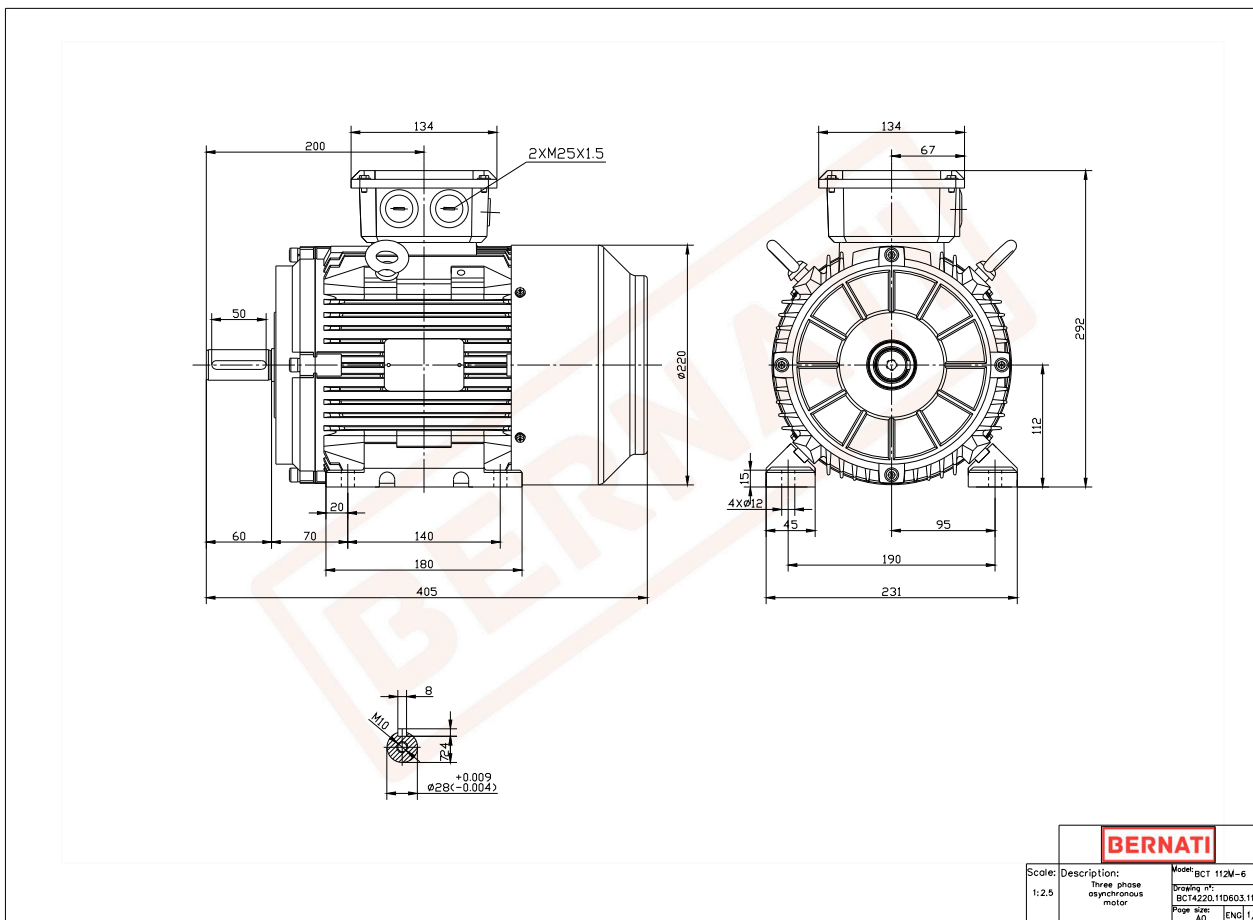

BCT

Product Code	BCT4220.11D603.11
Motor Type/Frame	BCT 112M-6
Mounting	IM B3
Efficiency Class	IE4
Output Power (kW)	2.20
Speed (rpm)	950
Tension (V)	230/400
Frequency (Hz)	50
Current (A)	5.10
Power factor (Cos Ø)	0.70
Poles	6
Insulation Class	F
IP Class	IP55
50% Efficiency	87.2
75% Efficiency	87.8
100% Efficiency	87.4
Torque (Nm)	22.10
Tstart / Tnominal	2.00
Istart / Inominal	7.50
Tmax / Tnominal	2.10
Noise (dB)	65
PTC Thermistor	PTC 130
Weight (Kg)	45
DE Bearing	6306 2RZ C3
NDE Bearing	6306 2RZ C3