

Technical Datasheet

BERNATI

BCT Series - Cast iron frame three phase low voltage electric motor

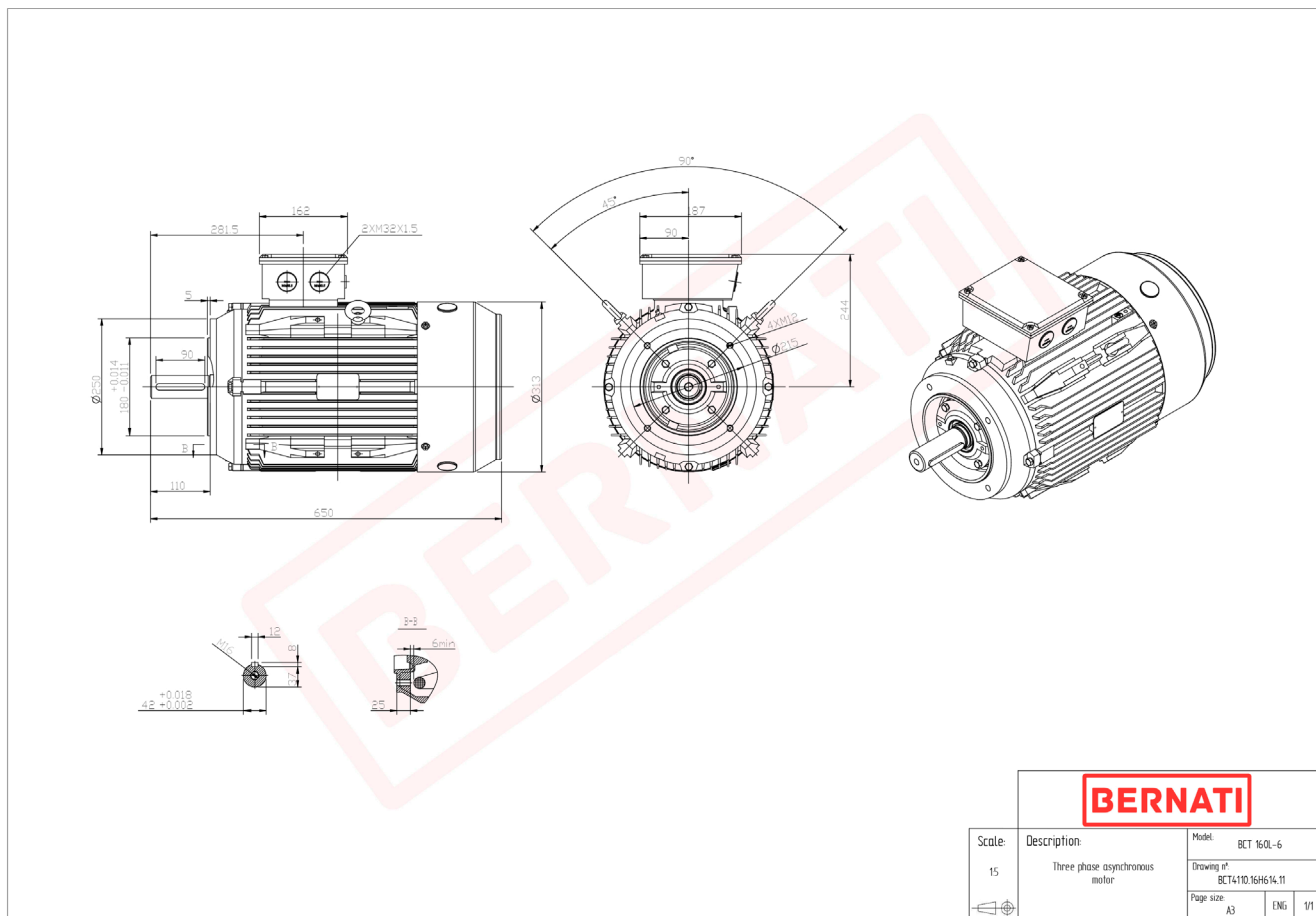

BCT

Product Code	BCT4110.16H614.11
Motor Type/Frame	BCT 160L-6
Mounting	IM B14
Efficiency Class	IE4
Output Power (kW)	11.00
Speed (rpm)	975
Tension (V)	230/400
Frequency (Hz)	50
Current (A)	22.30
Power factor (Cos Ø)	0.80
Poles	6
Insulation Class	F
IP Class	IP55
50% Efficiency	92.2
75% Efficiency	92.5
100% Efficiency	92.3
Torque (Nm)	107.80
Tstart / Tnominal	2.00
Istart / Inominal	8.50
Tmax / Tnominal	2.10
Noise (dB)	73
PTC Thermistor	PTC 130
Weight (Kg)	185
DE Bearing	6309 C3
NDE Bearing	6309 C3