

BCT Series - Cast iron frame three phase low voltage electric motor

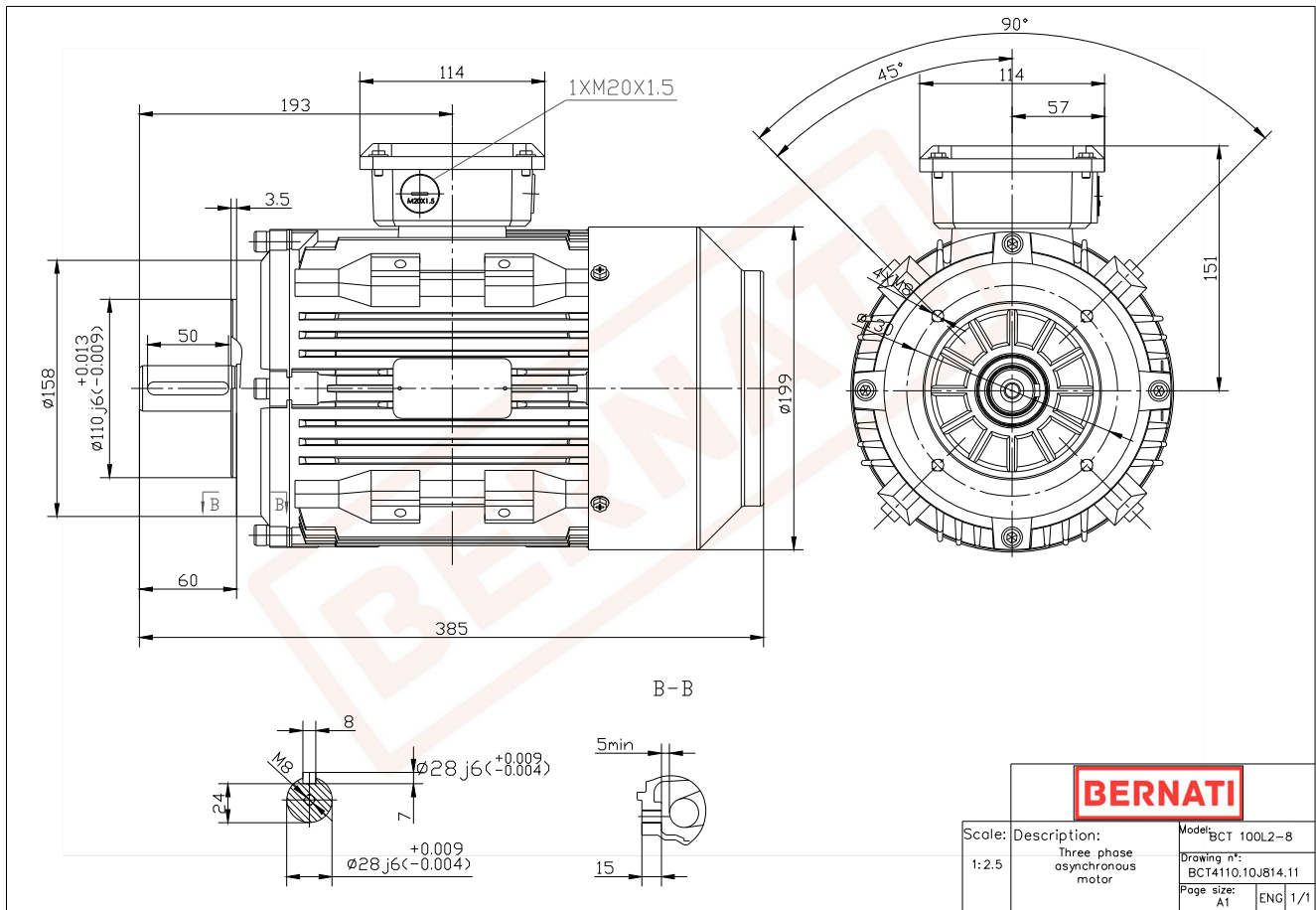

BCT

Product Code	BCT4110.10J814.11
Motor Type/Frame	BCT 100L2-8
Mounting	IM B14
Efficiency Class	IE4
Output Power (kW)	1.10
Speed (rpm)	700
Tension (V)	230/400
Frequency (Hz)	50
Current (A)	2.90
Power factor (Cos Ø)	0.70
Poles	8
Insulation Class	F
IP Class	IP55
50% Efficiency	80.6
75% Efficiency	81.0
100% Efficiency	80.8
Torque (Nm)	15.00
Tstart / Tnominal	2.00
Istart / Inominal	7.00
Tmax / Tnominal	2.00
Noise (dB)	59
PTC Thermistor	PTC 130
Weight (Kg)	34
DE Bearing	6206 2RZ C3
NDE Bearing	6206 2RZ C3