

Technical Datasheet

BERNATI

BCT Series - Cast iron frame three phase low voltage electric motor

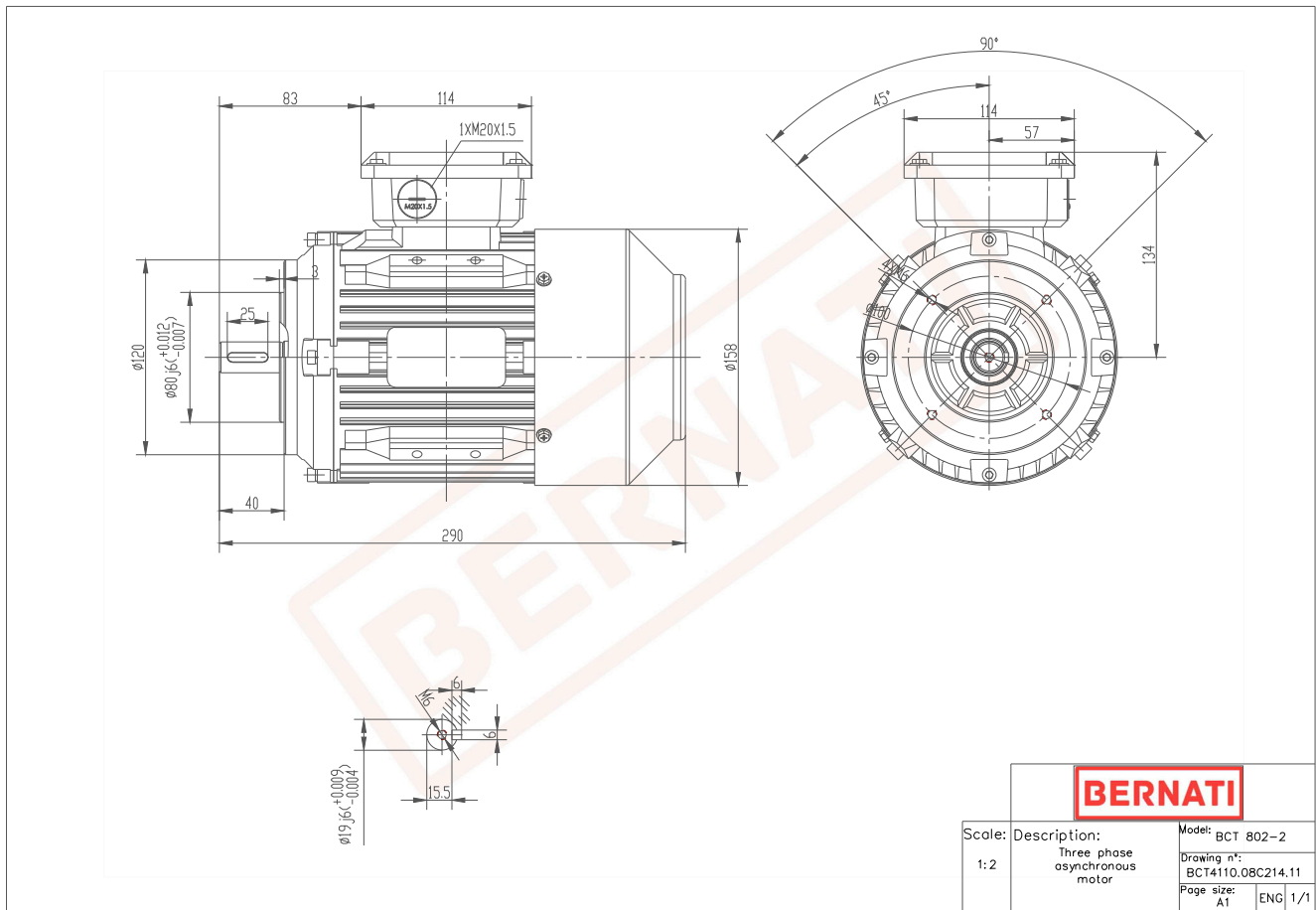

BCT

Product Code	BCT4110.08C214.11
Motor Type/Frame	BCT 802-2
Mounting	IM B14
Efficiency Class	IE4
Output Power (kW)	1.10
Speed (rpm)	2920
Tension (V)	230/400
Frequency (Hz)	50
Current (A)	2.30
Power factor (Cos Ø)	0.80
Poles	2
Insulation Class	F
IP Class	IP55
50% Efficiency	84.5
75% Efficiency	85.4
100% Efficiency	85.2
Torque (Nm)	3.60
Tstart / Tnominal	2.20
Istart / Inominal	8.50
Tmax / Tnominal	2.30
Noise (dB)	62
PTC Thermistor	PTC 130
Weight (Kg)	17
DE Bearing	6204 2RZ C3
NDE Bearing	6204 2RZ C3