

Technical Datasheet

BERNATI

BCT Series - Cast iron frame three phase low voltage electric motor

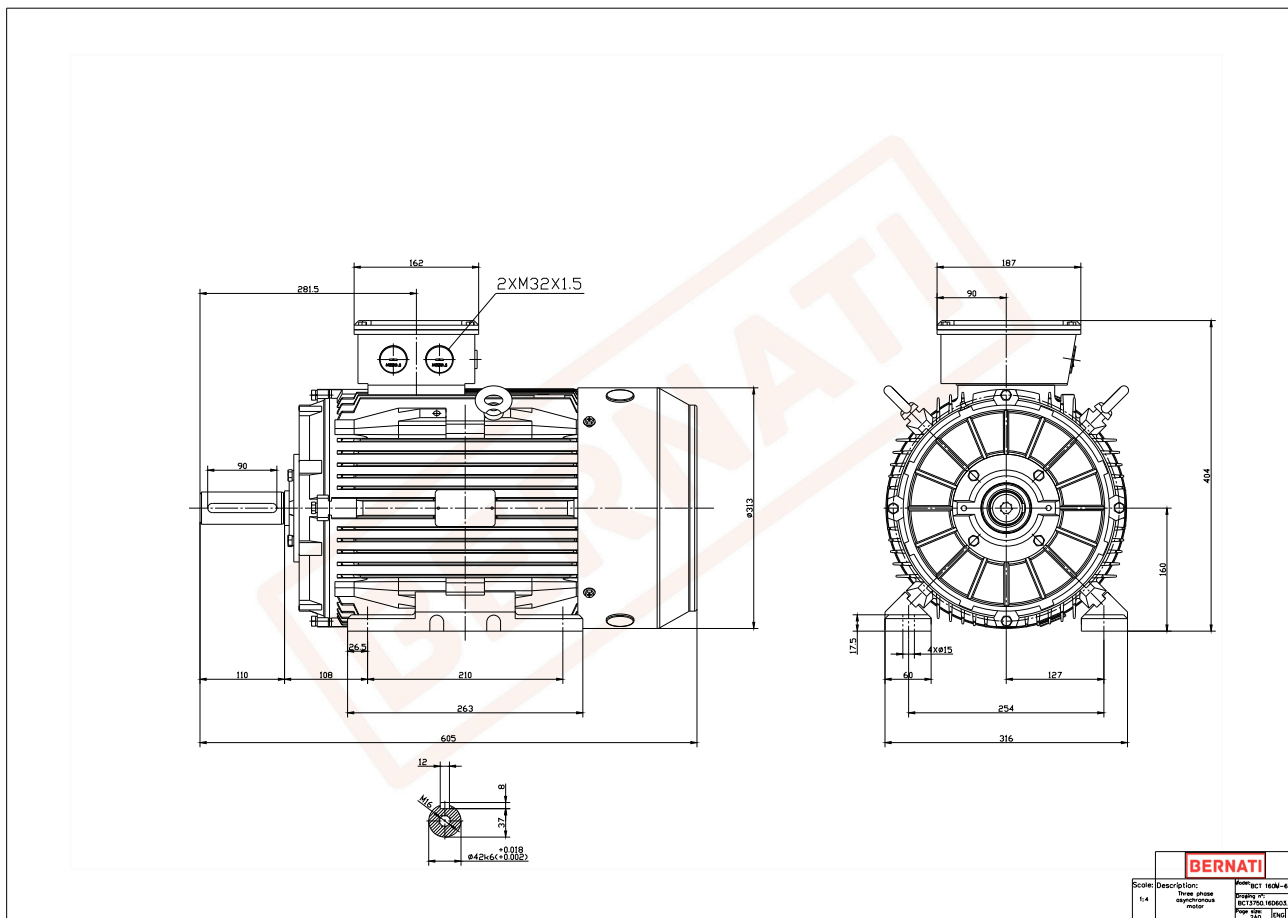

BCT

Product Code	BCT3750.16D603.11
Motor Type/Frame	BCT 160M-6
Mounting	IM B3
Efficiency Class	IE3
Output Power (kW)	7.50
Speed (rpm)	960
Tension (V)	230/400
Frequency (Hz)	50
Current (A)	16.20
Power factor (Cos Ø)	0.80
Poles	6
Insulation Class	F
IP Class	IP55
50% Efficiency	88.0
75% Efficiency	90.3
100% Efficiency	89.1
Torque (Nm)	74.60
Tstart / Tnominal	2.30
Istart / Inominal	7.50
Tmax / Tnominal	2.80
Noise (dB)	73
PTC Thermistor	PTC 130
Weight (Kg)	112
DE Bearing	6309 C3
NDE Bearing	6309 C3