

BCT Series - Cast iron frame three phase low voltage electric motor

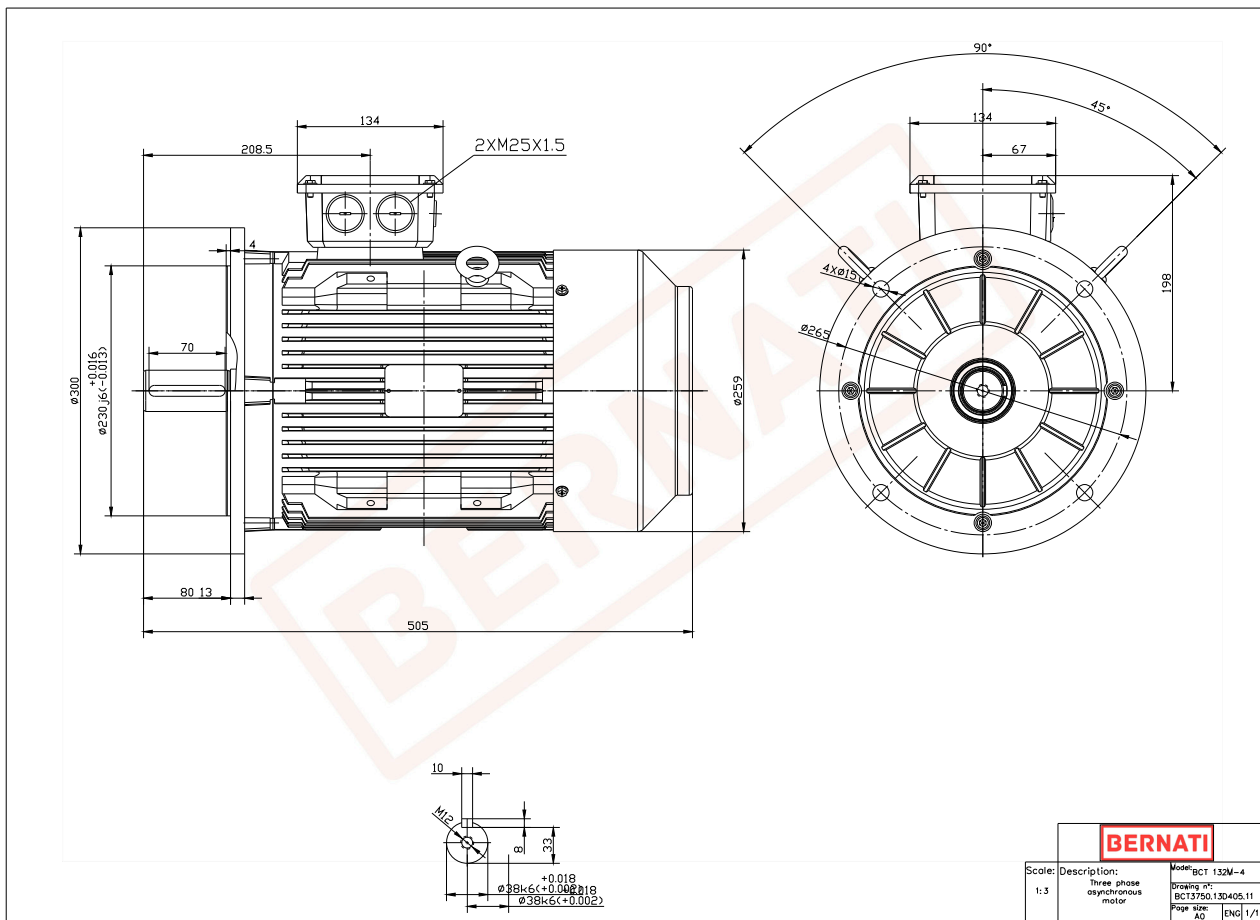

BCT

Product Code	BCT3750.13D405.11
Motor Type/Frame	BCT 132M-4
Mounting	IM B5
Efficiency Class	IE3
Output Power (kW)	7.50
Speed (rpm)	1440
Tension (V)	230/400
Frequency (Hz)	50
Current (A)	14.10
Power factor (Cos Ø)	0.90
Poles	4
Insulation Class	F
IP Class	IP55
50% Efficiency	91.2
75% Efficiency	91.3
100% Efficiency	90.4
Torque (Nm)	49.70
Tstart / Tnominal	2.50
Istart / Inominal	9.00
Tmax / Tnominal	3.00
Noise (dB)	71
PTC Thermistor	PTC 130
Weight (Kg)	79
DE Bearing	6308 2RZ C3
NDE Bearing	6308 2RZ C3