

Technical Datasheet

BERNATI

BCT Series - Cast iron frame three phase low voltage electric motor

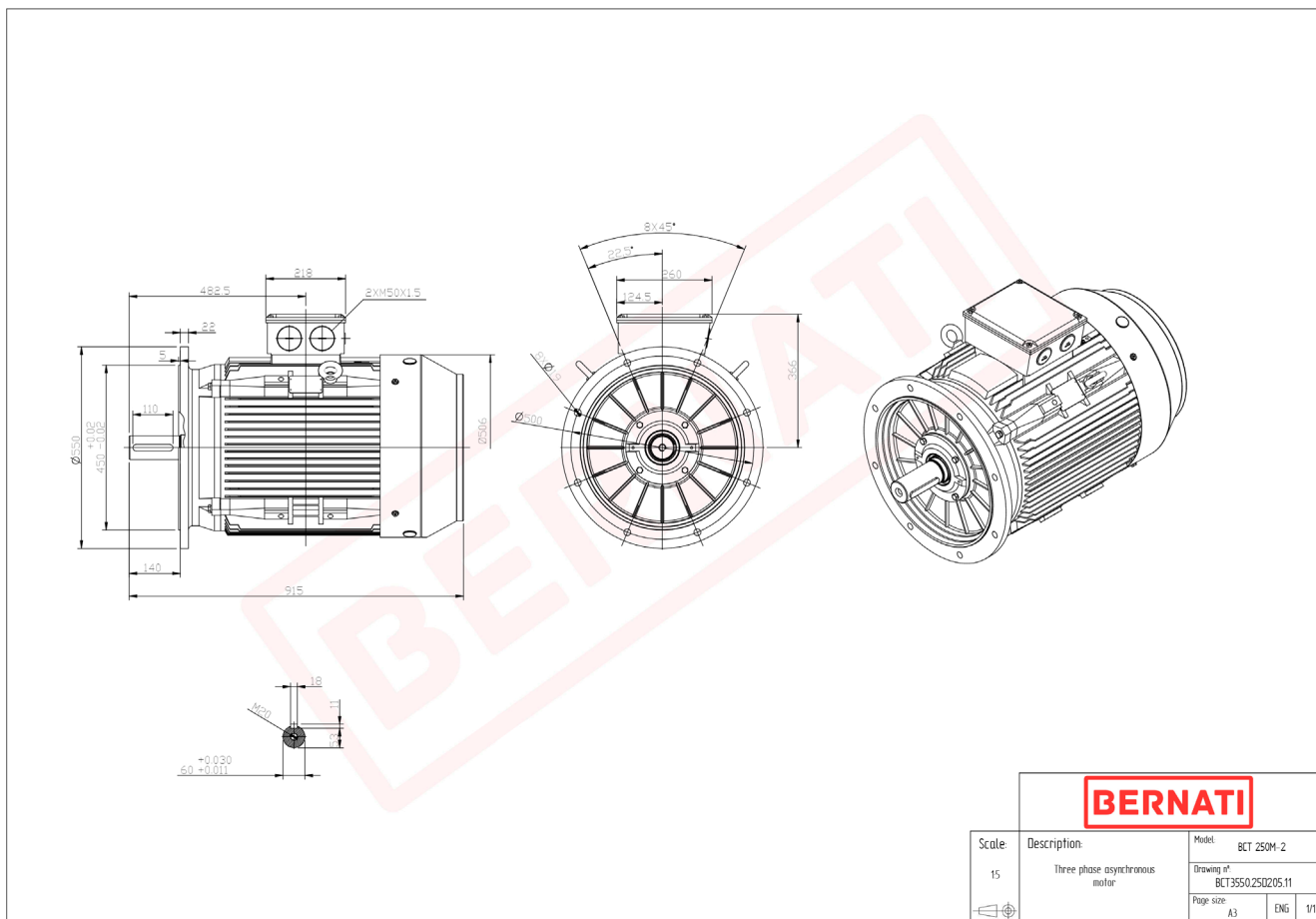

BCT

Product Code	BCT3550.25D205.11
Motor Type/Frame	BCT 250M-2
Mounting	IM B5
Efficiency Class	IE3
Output Power (kW)	55.00
Speed (rpm)	2960
Tension (V)	230/400
Frequency (Hz)	50
Current (A)	93.50
Power factor (Cos Ø)	0.90
Poles	2
Insulation Class	F
IP Class	IP55
50% Efficiency	93.1
75% Efficiency	94.5
100% Efficiency	94.3
Torque (Nm)	177.50
Tstart / Tnominal	2.50
Istart / Inominal	10.00
Tmax / Tnominal	2.60
Noise (dB)	93
PTC Thermistor	PTC 130
Weight (Kg)	428
DE Bearing	6314 C3
NDE Bearing	6314 C3