

Technical Datasheet

BERNATI

BCT Series - Cast iron frame three phase low voltage electric motor

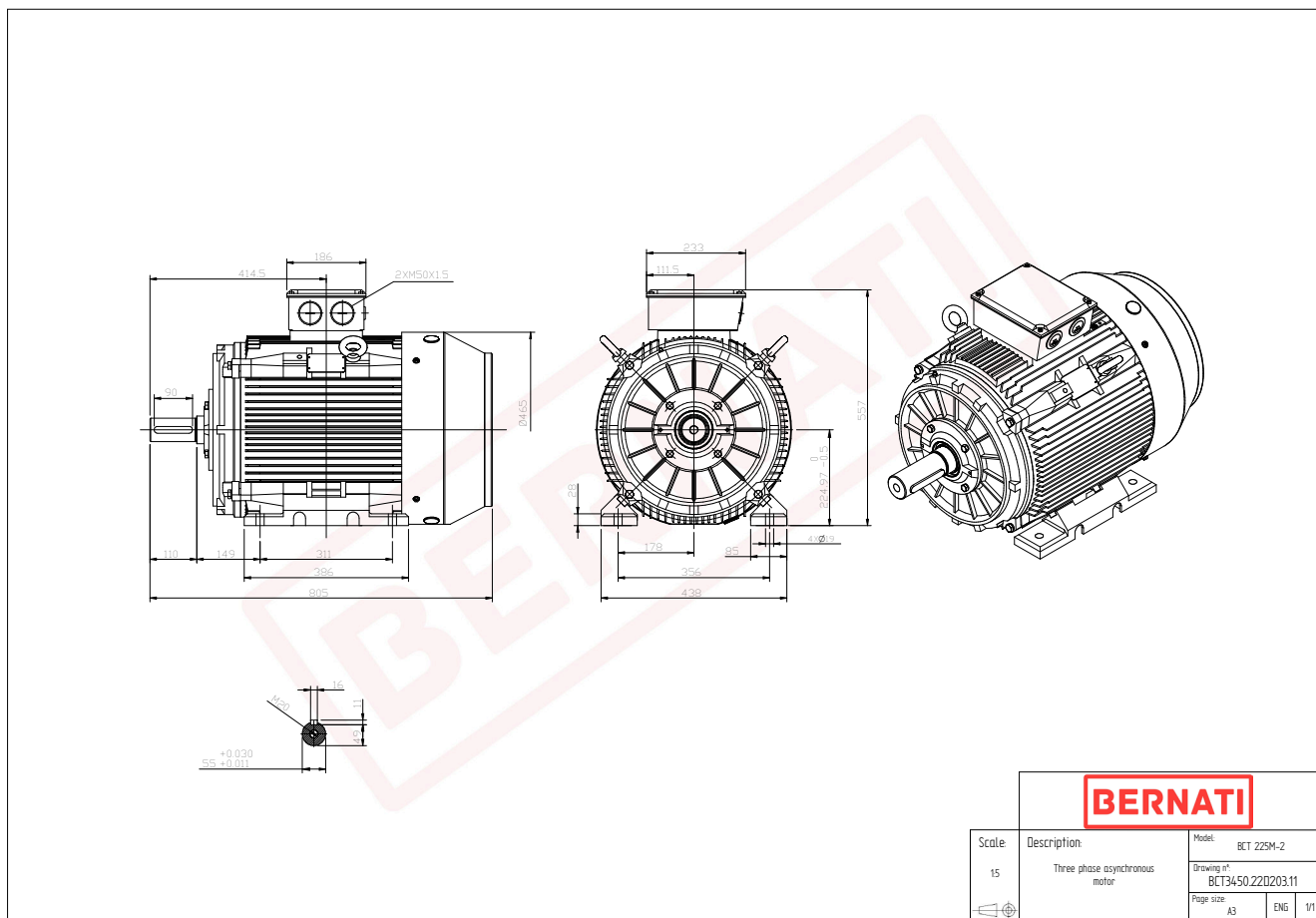

BCT

Product Code	BCT3450.22D203.11
Motor Type/Frame	BCT 225M-2
Mounting	IM B3
Efficiency Class	IE3
Output Power (kW)	45.00
Speed (rpm)	2950
Tension (V)	230/400
Frequency (Hz)	50
Current (A)	75.90
Power factor (Cos Ø)	0.90
Poles	2
Insulation Class	F
IP Class	IP55
50% Efficiency	94.1
75% Efficiency	94.6
100% Efficiency	94.0
Torque (Nm)	145.70
Tstart / Tnominal	2.50
Istart / Inominal	8.50
Tmax / Tnominal	2.50
Noise (dB)	92
PTC Thermistor	PTC 130
Weight (Kg)	369
DE Bearing	6313 C3
NDE Bearing	6313 C3