

## BCT Series - Cast iron frame three phase low voltage electric motor

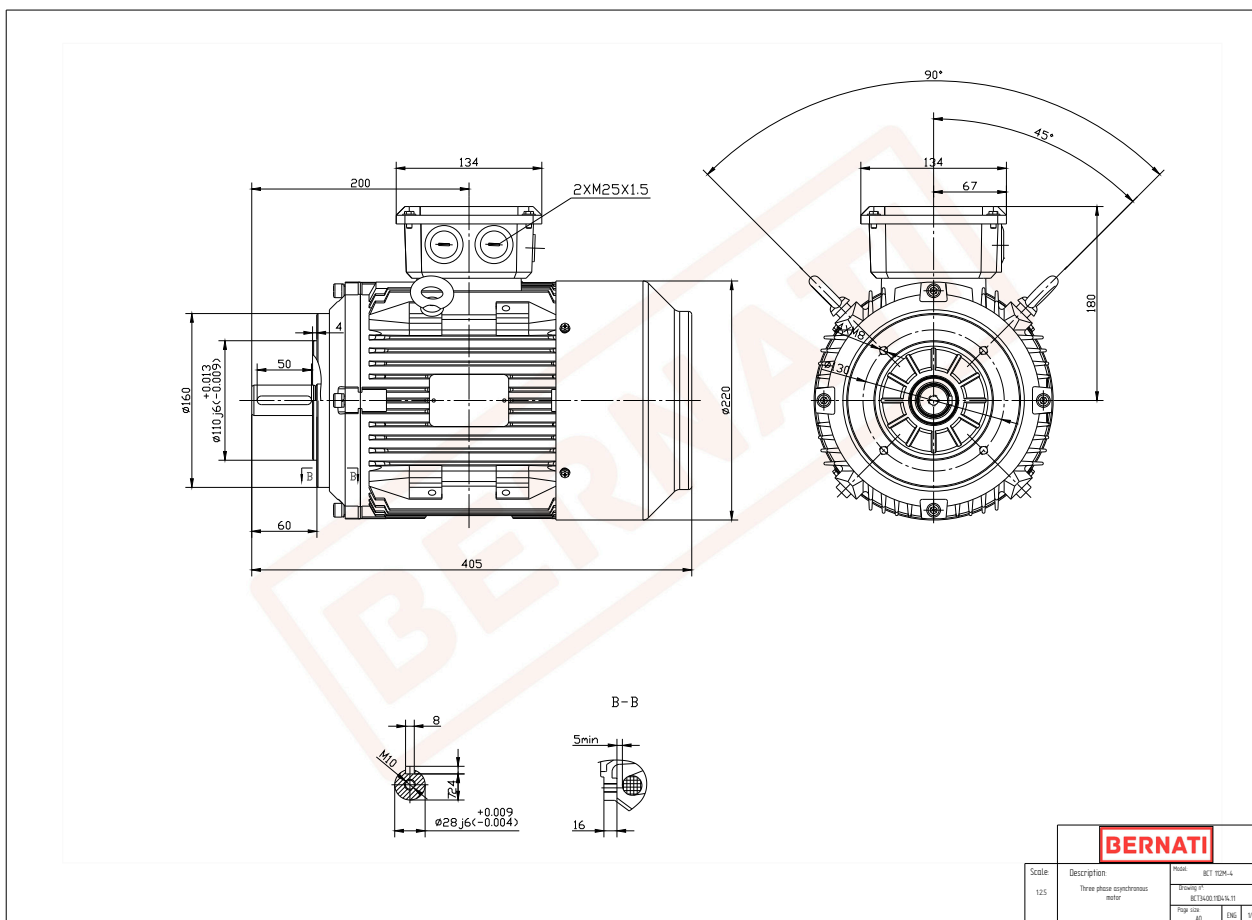

### BCT

Product Code	BCT3400.11D414.11
Motor Type/Frame	BCT 112M-4
Mounting	IM B14
Efficiency Class	IE3
Output Power (kW)	4.00
Speed (rpm)	1440
Tension (V)	230/400
Frequency (Hz)	50
Current (A)	8.00
Power factor (Cos Ø)	0.80
Poles	4
Insulation Class	F
IP Class	IP55
50% Efficiency	87.5
75% Efficiency	88.9
100% Efficiency	88.6
Torque (Nm)	26.50
Tstart / Tnominal	2.50
Istart / Inominal	8.60
Tmax / Tnominal	3.00
Noise (dB)	65
PTC Thermistor	PTC 130
Weight (Kg)	47
DE Bearing	6306 2RZ C3
NDE Bearing	6306 2RZ C3