

Technical Datasheet

BERNATI

BCT Series - Cast iron frame three phase low voltage electric motor

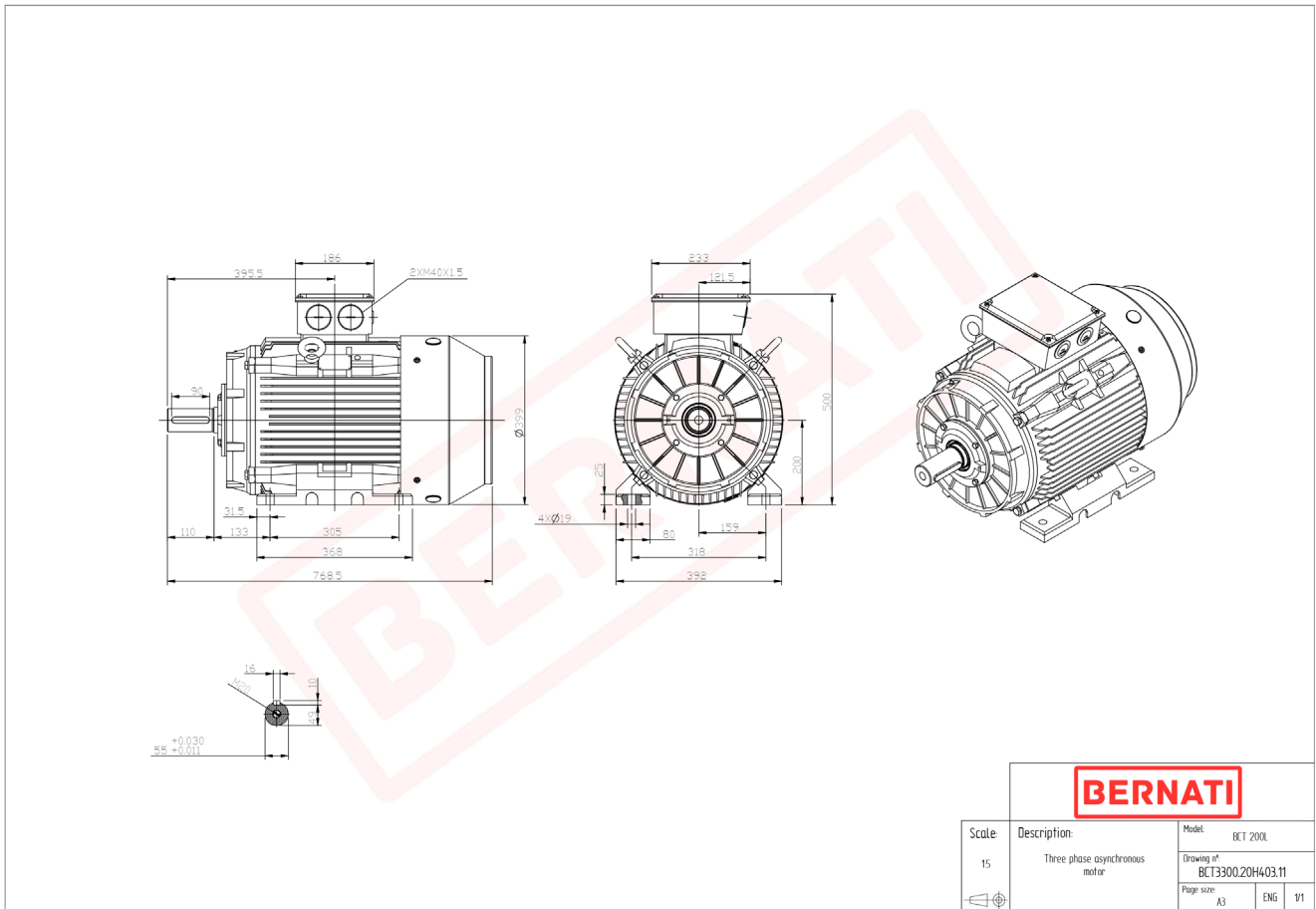

BCT

Product Code	BCT3300.20H403.11
Motor Type/Frame	BCT 200L-4
Mounting	IM B3
Efficiency Class	IE3
Output Power (kW)	30.00
Speed (rpm)	1470
Tension (V)	230/400
Frequency (Hz)	50
Current (A)	57.10
Power factor (Cos Ø)	0.80
Poles	4
Insulation Class	F
IP Class	IP55
50% Efficiency	93.2
75% Efficiency	93.7
100% Efficiency	93.6
Torque (Nm)	194.90
Tstart / Tnominal	2.50
Istart / Inominal	9.00
Tmax / Tnominal	2.80
Noise (dB)	79
PTC Thermistor	PTC 130
Weight (Kg)	252
DE Bearing	6312 C3
NDE Bearing	6312 C3