

BCT Series - Cast iron frame three phase low voltage electric motor

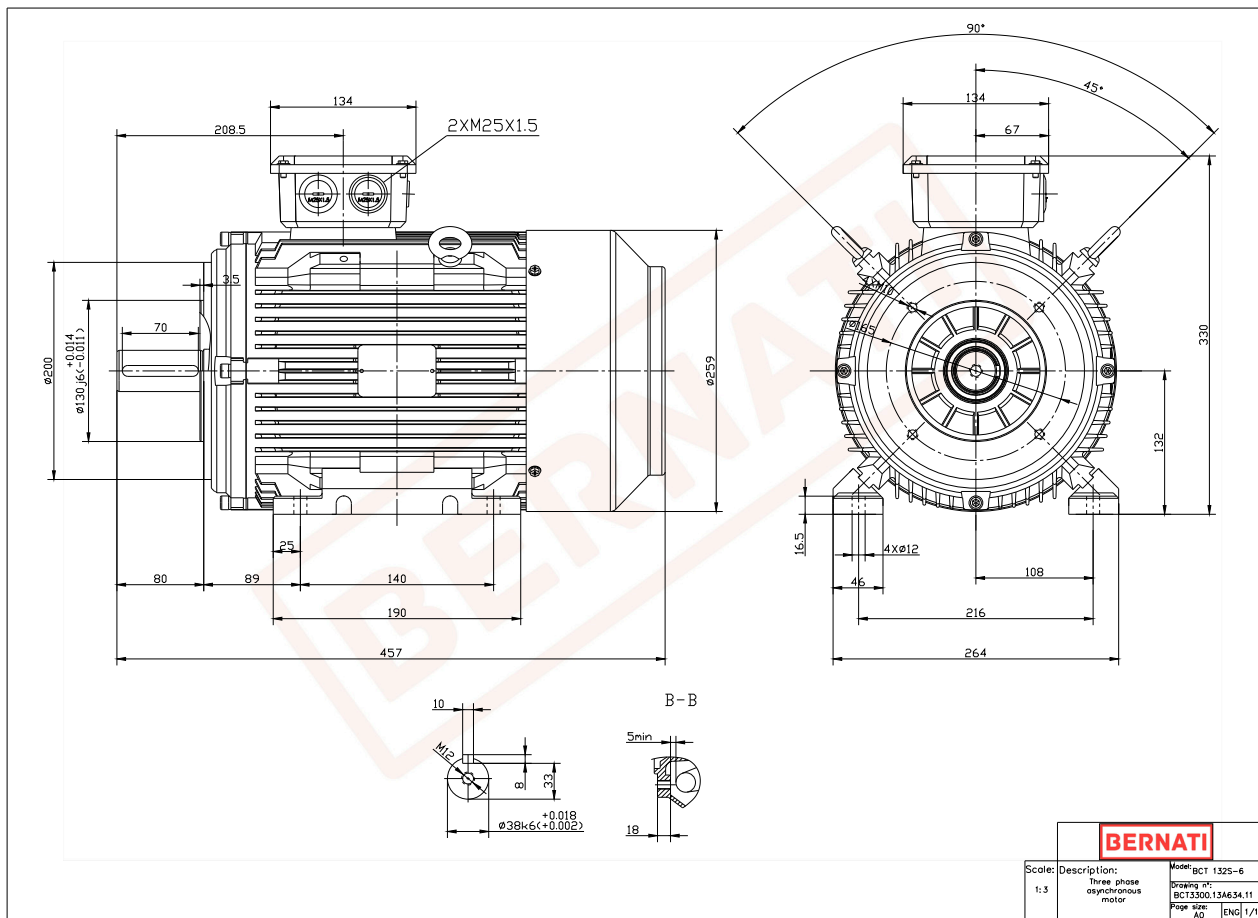

BCT	
Product Code	BCT3300.13A634.11
Motor Type/Frame	BCT 132S-6
Mounting	IM B3/B14
Efficiency Class	IE3
Output Power (kW)	3.00
Speed (rpm)	940
Tension (V)	230/400
Frequency (Hz)	50
Current (A)	6.80
Power factor (Cos ϕ)	0.70
Poles	6
Insulation Class	F
IP Class	IP55
50% Efficiency	84.5
75% Efficiency	86.1
100% Efficiency	85.6
Torque (Nm)	30.50
T _{start} / T _{nominal}	2.00
I _{start} / I _{nominal}	6.00
T _{max} / T _{nominal}	2.20
Noise (dB)	69
PTC Thermistor	PTC 130
Weight (Kg)	59
DE Bearing	6308 2RZ C3
NDE Bearing	6308 2RZ C3