

Technical Datasheet

BERNATI

BCT Series - Cast iron frame three phase low voltage electric motor

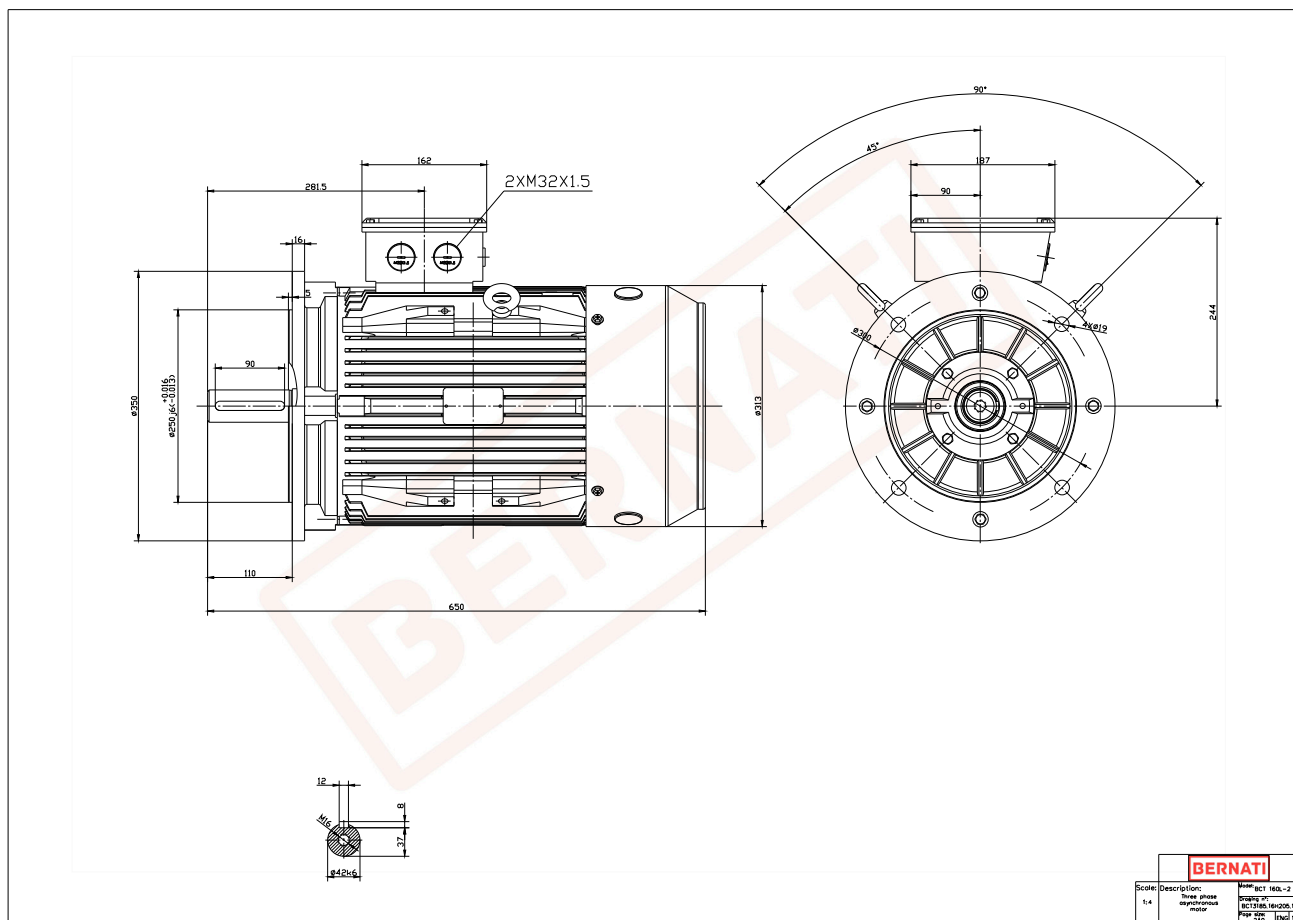

BCT

Product Code	BCT3185.16H205.11
Motor Type/Frame	BCT 160L-2
Mounting	IM B5
Efficiency Class	IE3
Output Power (kW)	18.50
Speed (rpm)	2940
Tension (V)	230/400
Frequency (Hz)	50
Current (A)	31.80
Power factor (Cos Ø)	0.90
Poles	2
Insulation Class	F
IP Class	IP55
50% Efficiency	93.3
75% Efficiency	93.5
100% Efficiency	92.4
Torque (Nm)	60.10
Tstart / Tnominal	2.50
Istart / Inominal	9.50
Tmax / Tnominal	3.00
Noise (dB)	86
PTC Thermistor	PTC 130
Weight (Kg)	144
DE Bearing	6309 C3
NDE Bearing	6309 C3