

# Technical Datasheet

**BERNATI**

BCT Series - Cast iron frame three phase low voltage electric motor

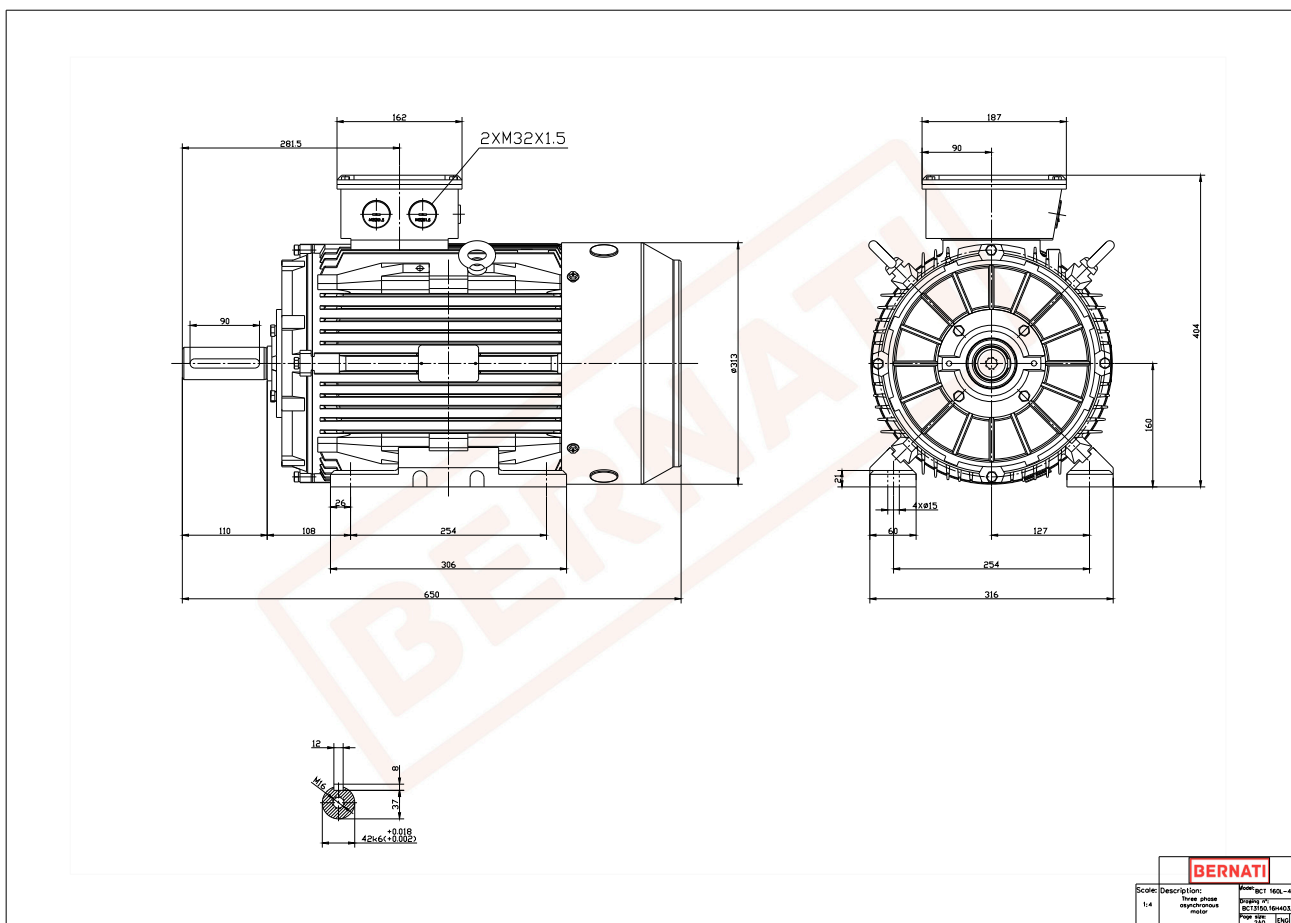

## BCT

Product Code	BCT3150.16H403.11
Motor Type/Frame	BCT 160L-4
Mounting	IM B3
Efficiency Class	IE3
Output Power (kW)	15.00
Speed (rpm)	1450
Tension (V)	230/400
Frequency (Hz)	50
Current (A)	27.30
Power factor (Cos Ø)	0.90
Poles	4
Insulation Class	F
IP Class	IP55
50% Efficiency	92.2
75% Efficiency	92.9
100% Efficiency	92.1
Torque (Nm)	98.80
Tstart / Tnominal	2.50
Istart / Inominal	8.50
Tmax / Tnominal	2.80
Noise (dB)	75
PTC Thermistor	PTC 130
Weight (Kg)	160
DE Bearing	6309 C3
NDE Bearing	6309 C3