

Technical Datasheet

BERNATI

BCT Series - Cast iron frame three phase low voltage electric motor

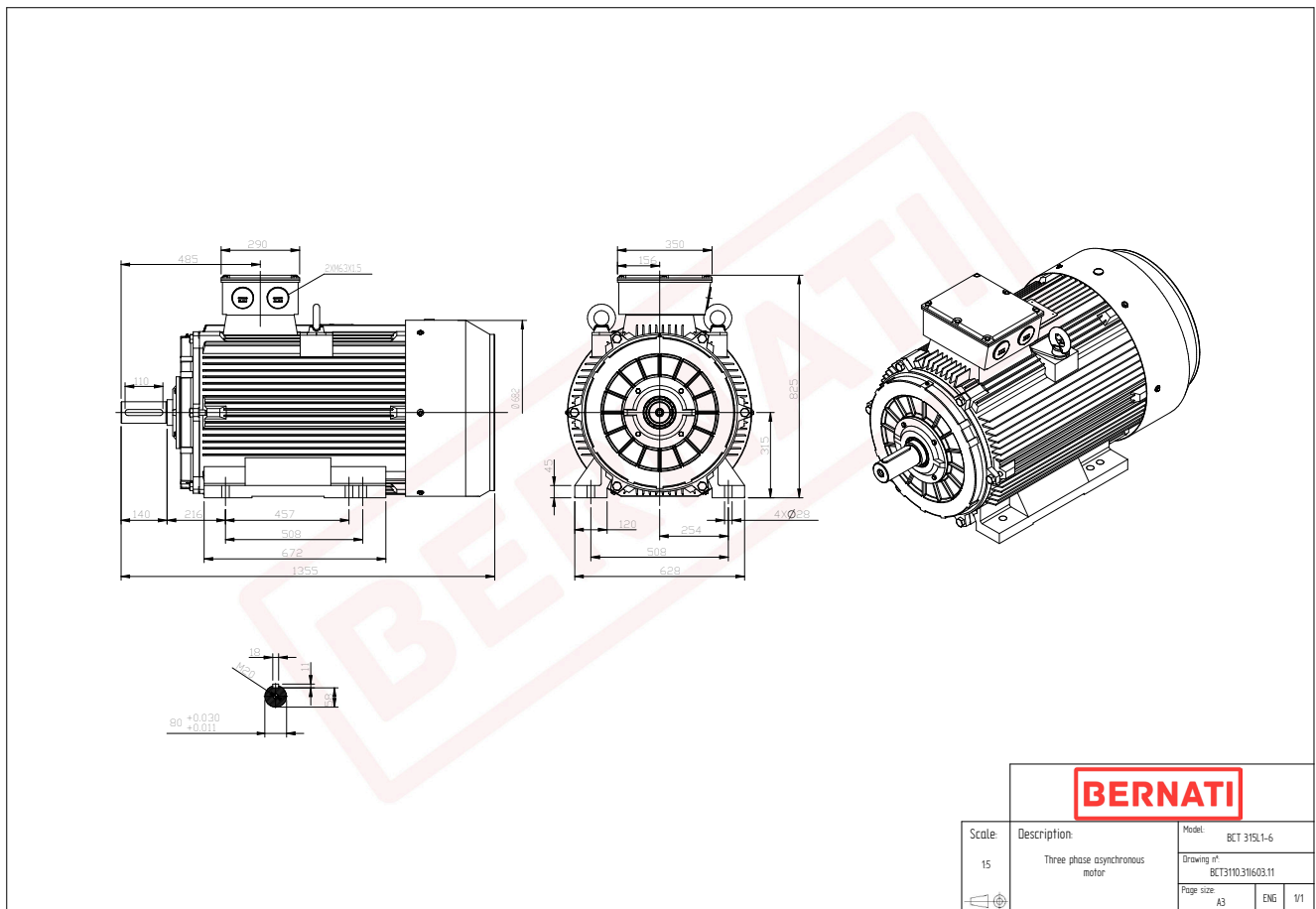

BCT

Product Code	BCT3110.31603.11
Motor Type/Frame	BCT 315L1-6
Mounting	IM B3
Efficiency Class	IE3
Output Power (kW)	110.00
Speed (rpm)	980
Tension (V)	230/400
Frequency (Hz)	50
Current (A)	203.60
Power factor (Cos Ø)	0.80
Poles	6
Insulation Class	F
IP Class	IP55
50% Efficiency	94.0
75% Efficiency	95.4
100% Efficiency	95.1
Torque (Nm)	1071.90
Tstart / Tnominal	2.00
Istart / Inominal	7.50
Tmax / Tnominal	2.30
Noise (dB)	85
PTC Thermistor	PTC 130
Weight (Kg)	1070
DE Bearing	NU319
NDE Bearing	6319 C3