

Technical Datasheet

BERNATI

BCT Series - Cast iron frame three phase low voltage electric motor

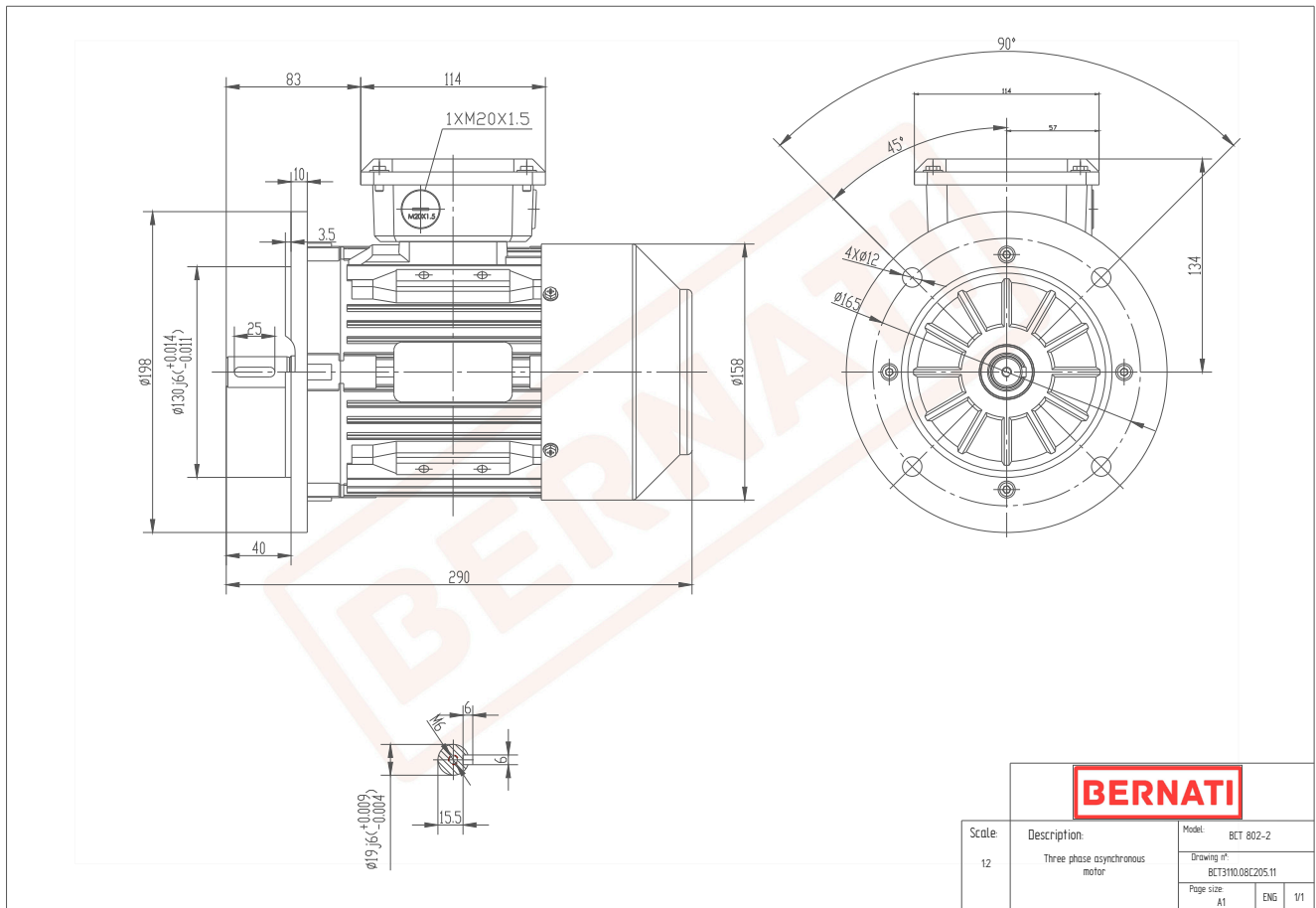

BCT

Product Code	BCT3110.08C205.11
Motor Type/Frame	BCT 802-2
Mounting	IM B5
Efficiency Class	IE3
Output Power (kW)	1.10
Speed (rpm)	2880
Tension (V)	230/400
Frequency (Hz)	50
Current (A)	2.40
Power factor (Cos Ø)	0.80
Poles	2
Insulation Class	F
IP Class	IP55
50% Efficiency	81.6
75% Efficiency	83.5
100% Efficiency	82.7
Torque (Nm)	3.70
Tstart / Tnominal	2.50
Istart / Inominal	8.00
Tmax / Tnominal	2.80
Noise (dB)	67
PTC Thermistor	PTC 130
Weight (Kg)	17
DE Bearing	6204 2RZ C3
NDE Bearing	6204 2RZ C3