

Technical Datasheet

BERNATI

BMT Series - Aluminum frame three phase low voltage electric motor

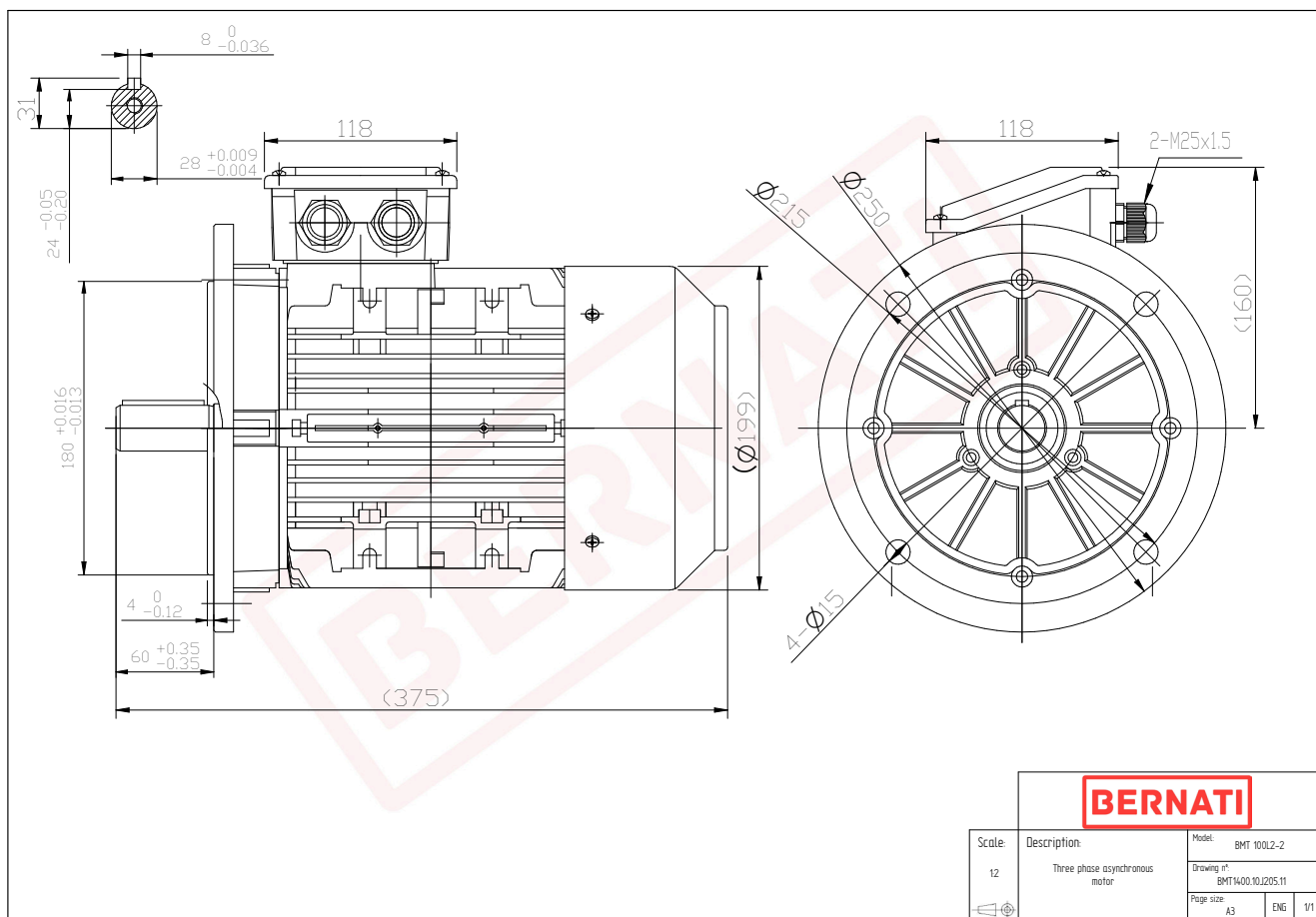

BMT	
Product Code	BMT1400.10J205.11
Motor Type/Frame	BMT 100L2-2
Mounting	IM B5
Efficiency Class	IE1
Output Power (kW)	4.00
Speed (rpm)	2890
Tension (V)	230/400
Frequency (Hz)	50
Current (A)	8.23
Power factor (Cos Ø)	0.83
Poles	2
Insulation Class	F
IP Class	IP55
50% Efficiency	82.1
75% Efficiency	84.4
100% Efficiency	84.5
Torque (Nm)	13.20
Tstart / Tnominal	3.10
Istart / Inominal	8.10
Tmax / Tnominal	3.60
Noise (dB)	77
PTC Thermistor	N/A
Weight (Kg)	23
DE Bearing	6206 2RZ C3
NDE Bearing	6206 2RZ C3