

Technical Datasheet

BERNATI

BMT Series - Aluminum frame three phase low voltage electric motor

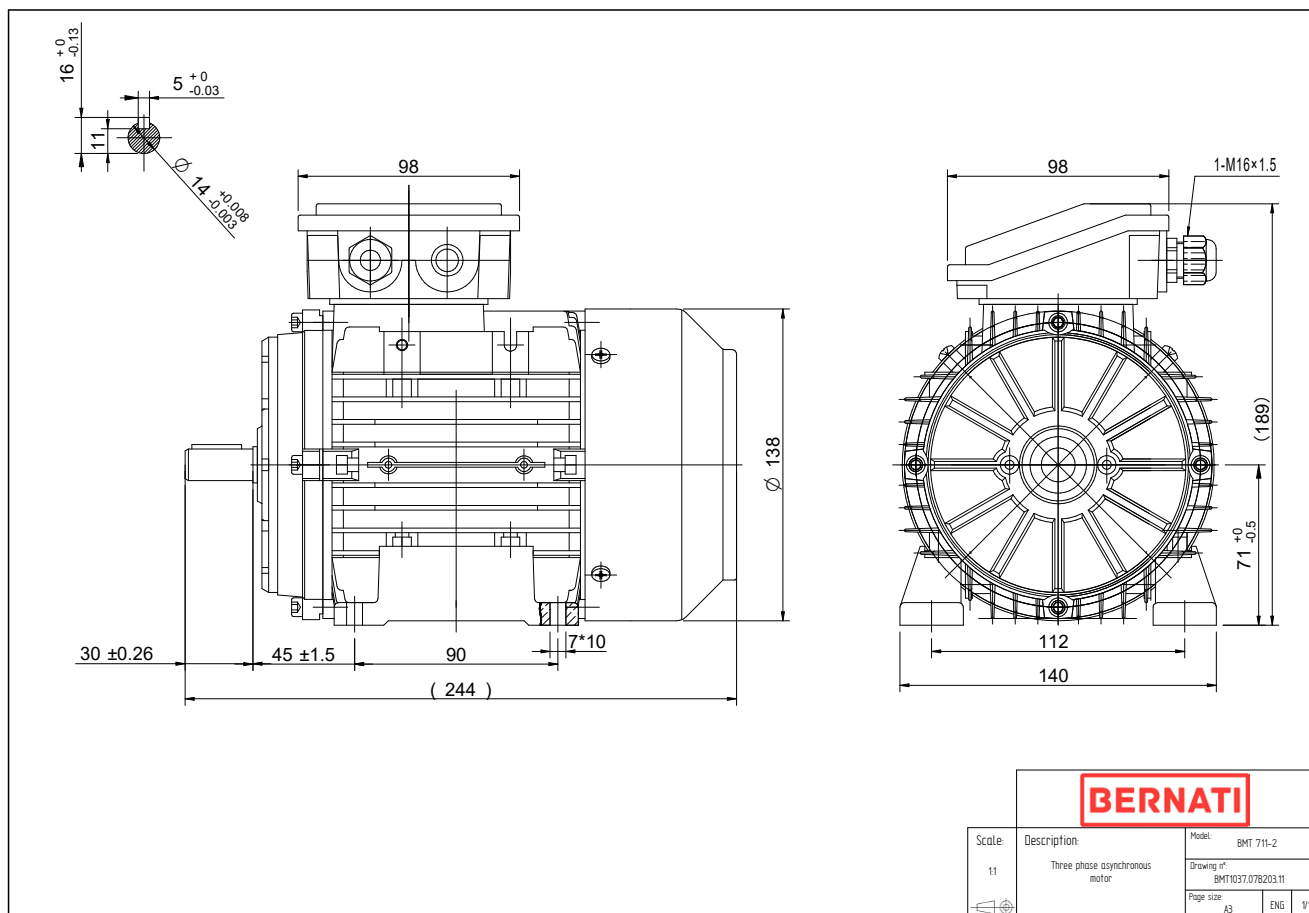

BMT

| | |
|----------------------|-------------------|
| Product Code | BMT1037.07B203.11 |
| Motor Type/Frame | BMT 711-2 |
| Mounting | IM B3 |
| Efficiency Class | IE1 |
| Output Power (kW) | 0.37 |
| Speed (rpm) | 2840 |
| Tension (V) | 230/400 |
| Frequency (Hz) | 50 |
| Current (A) | 0.91 |
| Power factor (Cos Ø) | 0.82 |
| Poles | 2 |
| Insulation Class | F |
| IP Class | IP55 |
| 50% Efficiency | 65.8 |
| 75% Efficiency | 70.9 |
| 100% Efficiency | 71.5 |
| Torque (Nm) | 1.20 |
| Tstart / Tnominal | 2.00 |
| Istart / Inominal | 5.10 |
| Tmax / Tnominal | 2.20 |
| Noise (dB) | 64 |
| PTC Thermistor | N/A |
| Weight (Kg) | 5 |
| DE Bearing | 6202 2RZ C3 |
| NDE Bearing | 6202 2RZ C3 |