

Technical Datasheet

BERNATI

BCT Series - Cast iron frame three phase low voltage electric motor

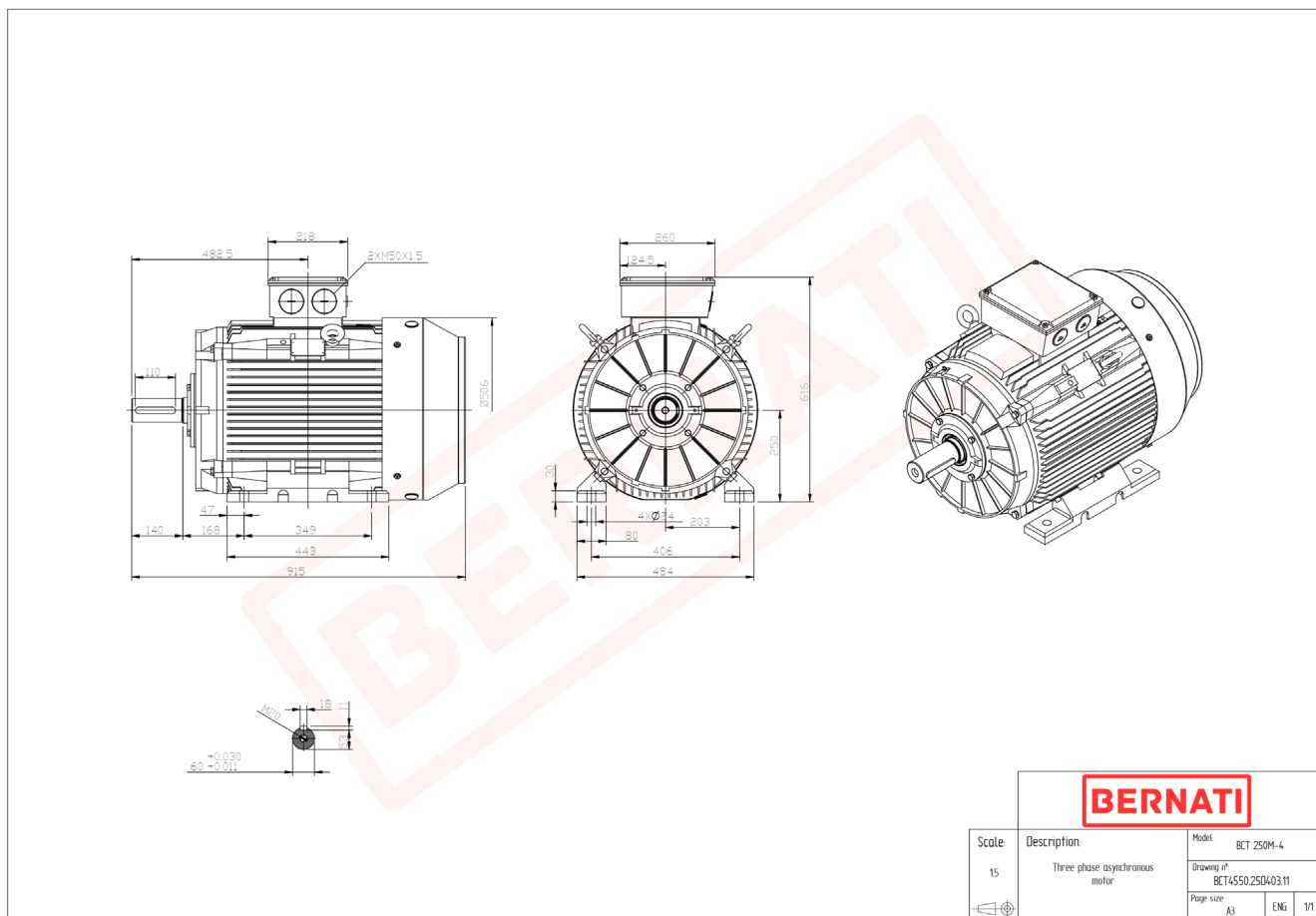

BCT

Product Code	BCT4550.25D403.11
Motor Type/Frame	BCT 250M-4
Mounting	IM B3
Efficiency Class	IE4
Output Power (kW)	55.00
Speed (rpm)	1480
Tension (V)	230/400
Frequency (Hz)	50
Current (A)	96.50
Power factor (Cos Ø)	0.90
Poles	4
Insulation Class	F
IP Class	IP55
50% Efficiency	95.3
75% Efficiency	95.9
100% Efficiency	95.7
Torque (Nm)	355.00
Tstart / Tnominal	2.00
Istart / Inominal	9.00
Tmax / Tnominal	2.30
Noise (dB)	79
PTC Thermistor	PTC 130
Weight (Kg)	550
DE Bearing	6314 C3
NDE Bearing	6314 C3