

Technical Datasheet

BERNATI

BCT Series - Cast iron frame three phase low voltage electric motor

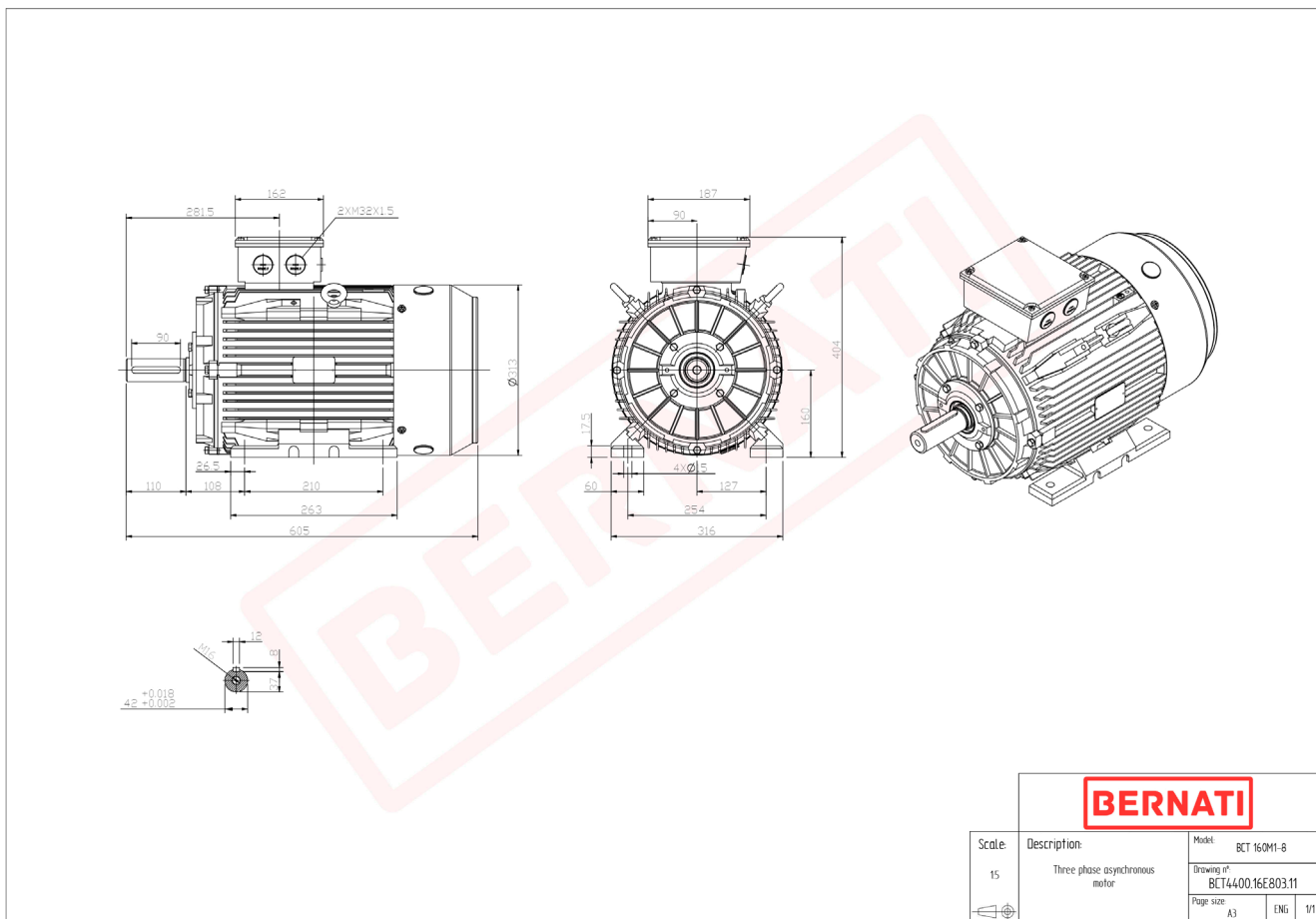

BCT

Product Code	BCT4400.16E803.11
Motor Type/Frame	BCT 160M1-8
Mounting	IM B3
Efficiency Class	IE4
Output Power (kW)	4.00
Speed (rpm)	725
Tension (V)	230/400
Frequency (Hz)	50
Current (A)	9.30
Power factor (Cos Ø)	0.70
Poles	8
Insulation Class	F
IP Class	IP55
50% Efficiency	86.9
75% Efficiency	87.3
100% Efficiency	87.1
Torque (Nm)	52.70
Tstart / Tnominal	1.80
Istart / Inominal	7.90
Tmax / Tnominal	2.00
Noise (dB)	68
PTC Thermistor	PTC 130
Weight (Kg)	117
DE Bearing	6309 C3
NDE Bearing	6309 C3