

BCT Series - Cast iron frame three phase low voltage electric motor

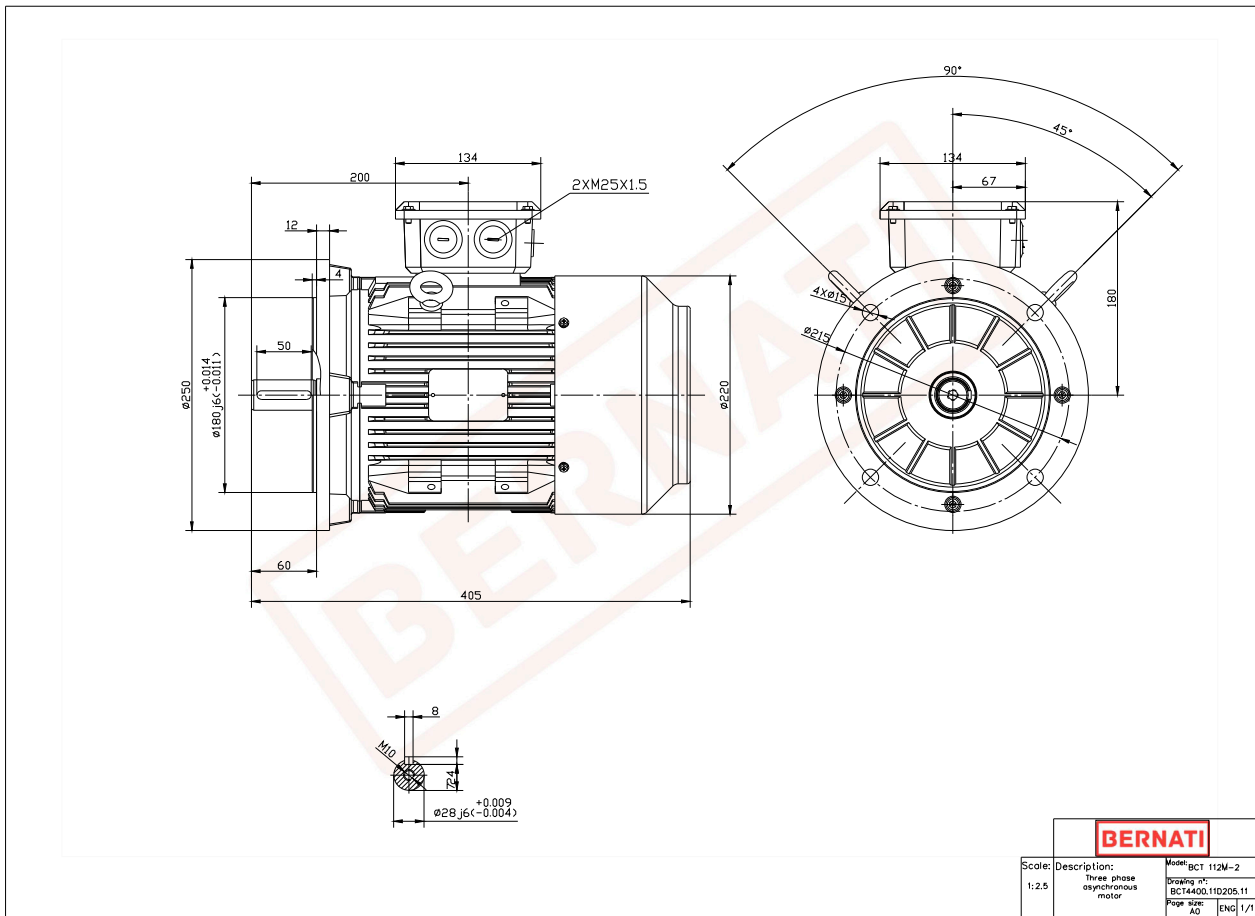

BCT

Product Code	BCT4400.11D205.11
Motor Type/Frame	BCT 112M-2
Mounting	IM B5
Efficiency Class	IE4
Output Power (kW)	4.00
Speed (rpm)	2945
Tension (V)	230/400
Frequency (Hz)	50
Current (A)	7.30
Power factor (Cos Ø)	0.90
Poles	2
Insulation Class	F
IP Class	IP55
50% Efficiency	89.8
75% Efficiency	90.2
100% Efficiency	90.0
Torque (Nm)	13.00
Tstart / Tnominal	2.20
Istart / Inominal	9.50
Tmax / Tnominal	2.30
Noise (dB)	77
PTC Thermistor	PTC 130
Weight (Kg)	50
DE Bearing	6306 2RZ C3
NDE Bearing	6306 2RZ C3