

BCT Series - Cast iron frame three phase low voltage electric motor

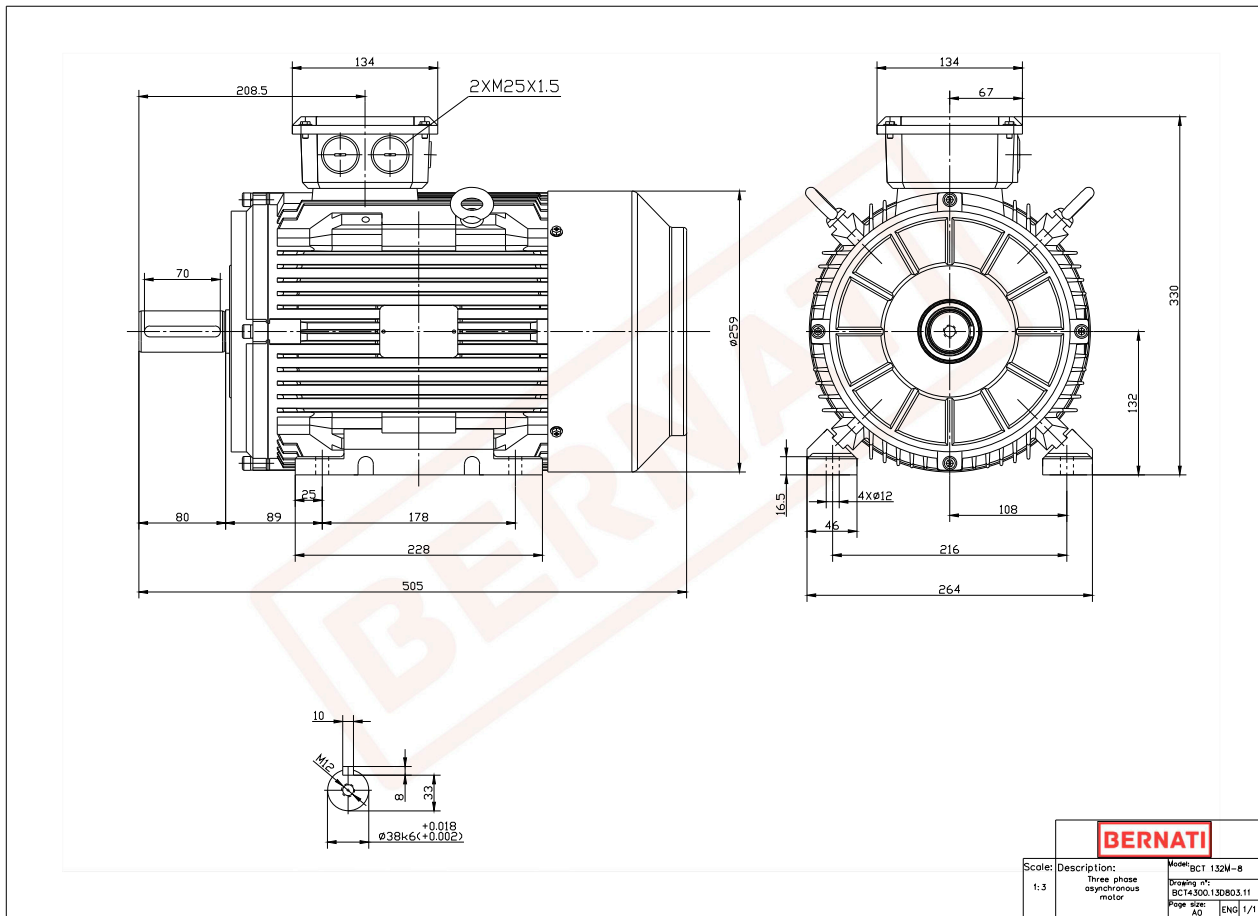

BCT

Product Code	BCT4300.13D803.11
Motor Type/Frame	BCT 132M-8
Mounting	IM B3
Efficiency Class	IE4
Output Power (kW)	3.00
Speed (rpm)	715
Tension (V)	230/400
Frequency (Hz)	50
Current (A)	7.20
Power factor (Cos Ø)	0.70
Poles	8
Insulation Class	F
IP Class	IP55
50% Efficiency	85.6
75% Efficiency	86.2
100% Efficiency	85.9
Torque (Nm)	40.10
Tstart / Tnominal	1.80
Istart / Inominal	7.80
Tmax / Tnominal	2.00
Noise (dB)	64
PTC Thermistor	PTC 130
Weight (Kg)	64
DE Bearing	6308 2RZ C3
NDE Bearing	6308 2RZ C3