

## BCT Series - Cast iron frame three phase low voltage electric motor

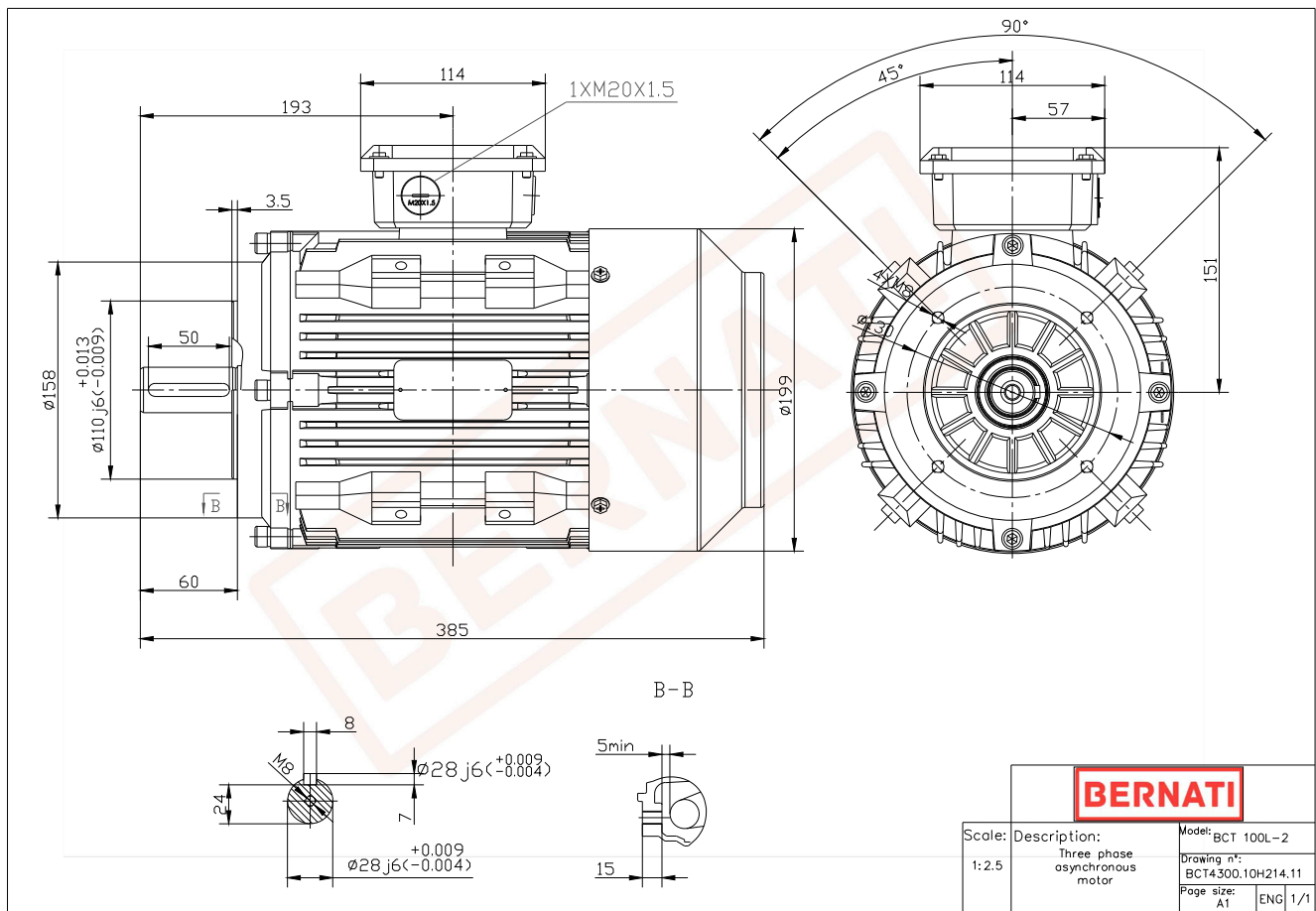

### BCT

Product Code	BCT4300.10H214.11
Motor Type/Frame	BCT 100L-2
Mounting	IM B14
Efficiency Class	IE4
Output Power (kW)	3.00
Speed (rpm)	2945
Tension (V)	230/400
Frequency (Hz)	50
Current (A)	5.60
Power factor (Cos Ø)	0.90
Poles	2
Insulation Class	F
IP Class	IP55
50% Efficiency	88.9
75% Efficiency	89.3
100% Efficiency	89.1
Torque (Nm)	9.70
Tstart / Tnominal	2.20
Istart / Inominal	9.50
Tmax / Tnominal	2.30
Noise (dB)	74
PTC Thermistor	PTC 130
Weight (Kg)	36
DE Bearing	6206 2RZ C3
NDE Bearing	6206 2RZ C3