

Technical Datasheet

BERNATI

BCT Series - Cast iron frame three phase low voltage electric motor

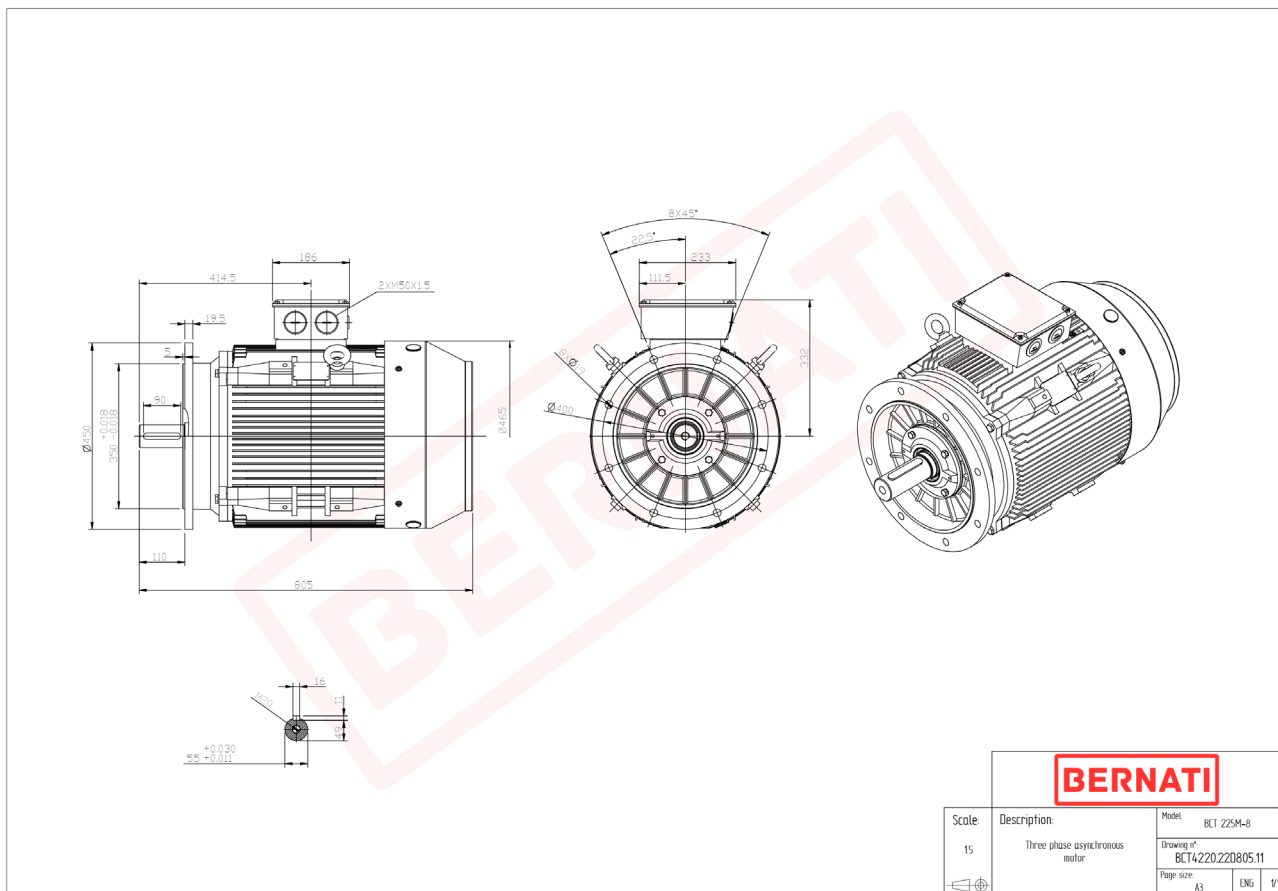

BCT

Product Code	BCT4220.22D805.11
Motor Type/Frame	BCT 225M-8
Mounting	IM B5
Efficiency Class	IE4
Output Power (kW)	22.00
Speed (rpm)	740
Tension (V)	230/400
Frequency (Hz)	50
Current (A)	45.40
Power factor (Cos Ø)	0.80
Poles	8
Insulation Class	F
IP Class	IP55
50% Efficiency	92.0
75% Efficiency	92.3
100% Efficiency	92.1
Torque (Nm)	284.00
Tstart / Tnominal	1.80
Istart / Inominal	8.30
Tmax / Tnominal	2.00
Noise (dB)	73
PTC Thermistor	PTC 130
Weight (Kg)	319
DE Bearing	6313 C3
NDE Bearing	6313 C3