

Technical Datasheet

BERNATI

BCT Series - Cast iron frame three phase low voltage electric motor

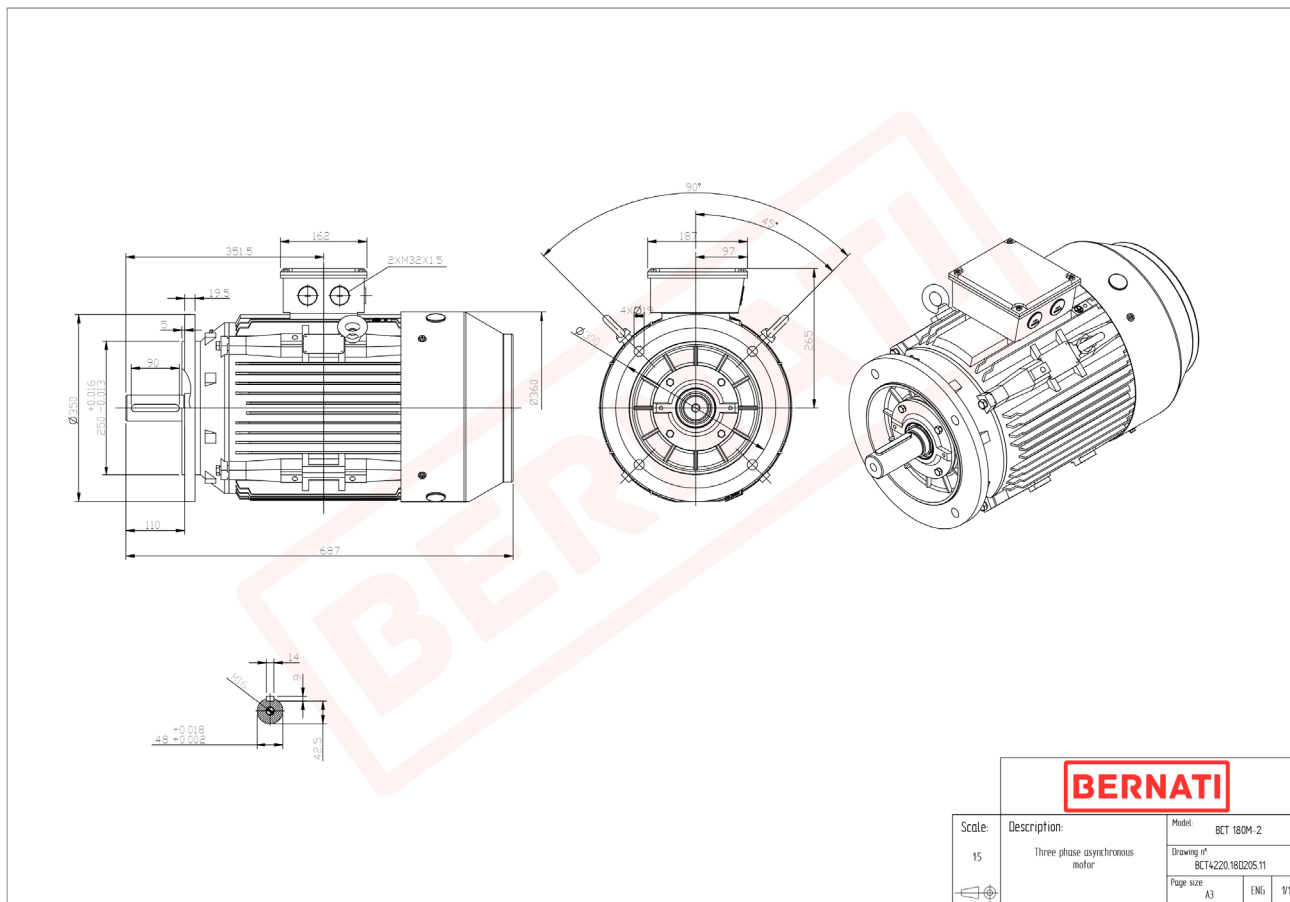

BCT

Product Code	BCT4220.18D205.11
Motor Type/Frame	BCT 180M-2
Mounting	IM B5
Efficiency Class	IE4
Output Power (kW)	22.00
Speed (rpm)	2965
Tension (V)	230/400
Frequency (Hz)	50
Current (A)	38.00
Power factor (Cos Ø)	0.90
Poles	2
Insulation Class	F
IP Class	IP55
50% Efficiency	93.8
75% Efficiency	94.2
100% Efficiency	94.0
Torque (Nm)	70.90
Tstart / Tnominal	2.00
Istart / Inominal	9.50
Tmax / Tnominal	2.30
Noise (dB)	83
PTC Thermistor	PTC 130
Weight (Kg)	220
DE Bearing	6311 C3
NDE Bearing	6311 C3