

Technical Datasheet

BERNATI

BCT Series - Cast iron frame three phase low voltage electric motor

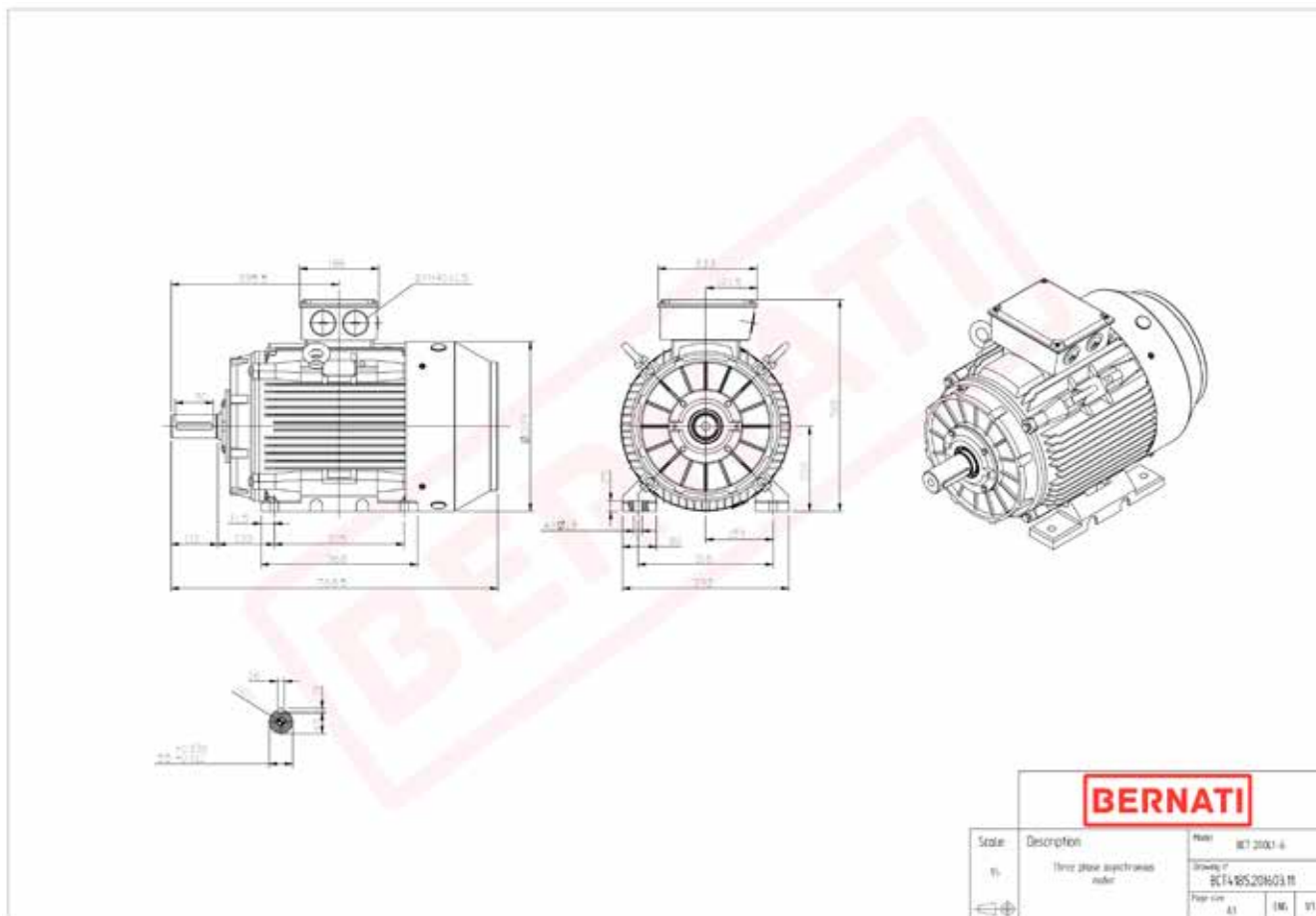

BCT

Product Code	BCT4185.201603.11
Motor Type/Frame	BCT 200L1-6
Mounting	IM B3
Efficiency Class	IE4
Output Power (kW)	18.50
Speed (rpm)	975
Tension (V)	230/400
Frequency (Hz)	50
Current (A)	35.70
Power factor (Cos Ø)	0.80
Poles	6
Insulation Class	F
IP Class	IP55
50% Efficiency	93.3
75% Efficiency	93.6
100% Efficiency	93.4
Torque (Nm)	181.30
Tstart / Tnominal	2.00
Istart / Inominal	8.50
Tmax / Tnominal	2.10
Noise (dB)	73
PTC Thermistor	PTC 130
Weight (Kg)	246
DE Bearing	6312 C3
NDE Bearing	6312 C3