

# Technical Datasheet

**BERNATI**

BCT Series - Cast iron frame three phase low voltage electric motor

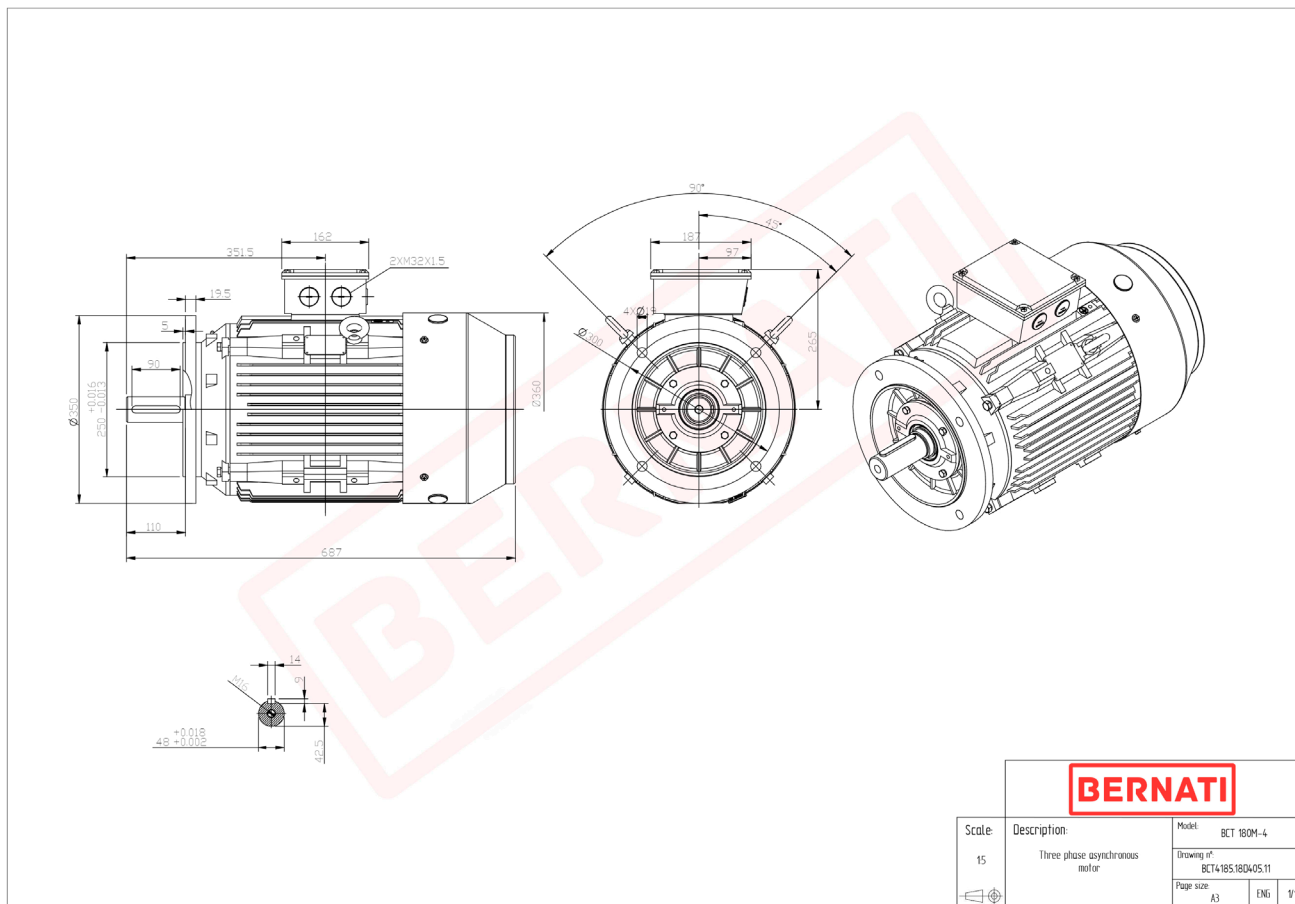

## BCT

Product Code	BCT4185.18D405.11
Motor Type/Frame	BCT 180M-4
Mounting	IM B5
Efficiency Class	IE4
Output Power (kW)	18.50
Speed (rpm)	1475
Tension (V)	230/400
Frequency (Hz)	50
Current (A)	33.40
Power factor (Cos Ø)	0.90
Poles	4
Insulation Class	F
IP Class	IP55
50% Efficiency	93.6
75% Efficiency	94.4
100% Efficiency	94.2
Torque (Nm)	119.80
Tstart / Tnominal	2.00
Istart / Inominal	9.50
Tmax / Tnominal	2.30
Noise (dB)	76
PTC Thermistor	PTC 130
Weight (Kg)	218
DE Bearing	6311 C3
NDE Bearing	6311 C3