

Technical Datasheet

BERNATI

BCT Series - Cast iron frame three phase low voltage electric motor

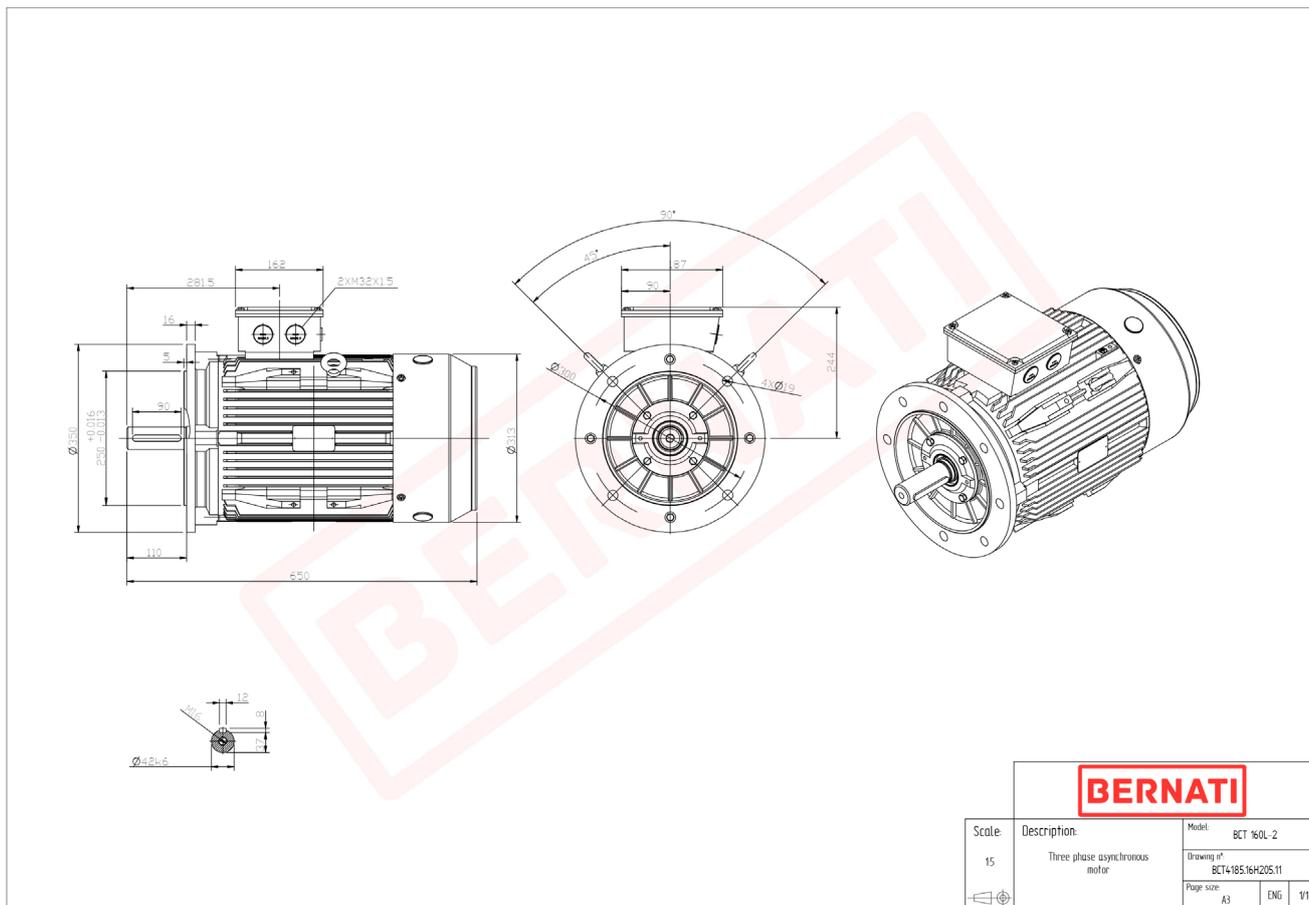

BCT

Product Code	BCT4185.16H205.11
Motor Type/Frame	BCT 160L-2
Mounting	IM B5
Efficiency Class	IE4
Output Power (kW)	18.50
Speed (rpm)	2965
Tension (V)	230/400
Frequency (Hz)	50
Current (A)	32.00
Power factor (Cos Ø)	0.90
Poles	2
Insulation Class	F
IP Class	IP55
50% Efficiency	93.6
75% Efficiency	93.9
100% Efficiency	93.7
Torque (Nm)	59.60
Tstart / Tnominal	2.00
Istart / Inominal	9.50
Tmax / Tnominal	2.30
Noise (dB)	81
PTC Thermistor	PTC 130
Weight (Kg)	176
DE Bearing	6309 C3
NDE Bearing	6309 C3