

# Technical Datasheet

**BERNATI**

BCT Series - Cast iron frame three phase low voltage electric motor

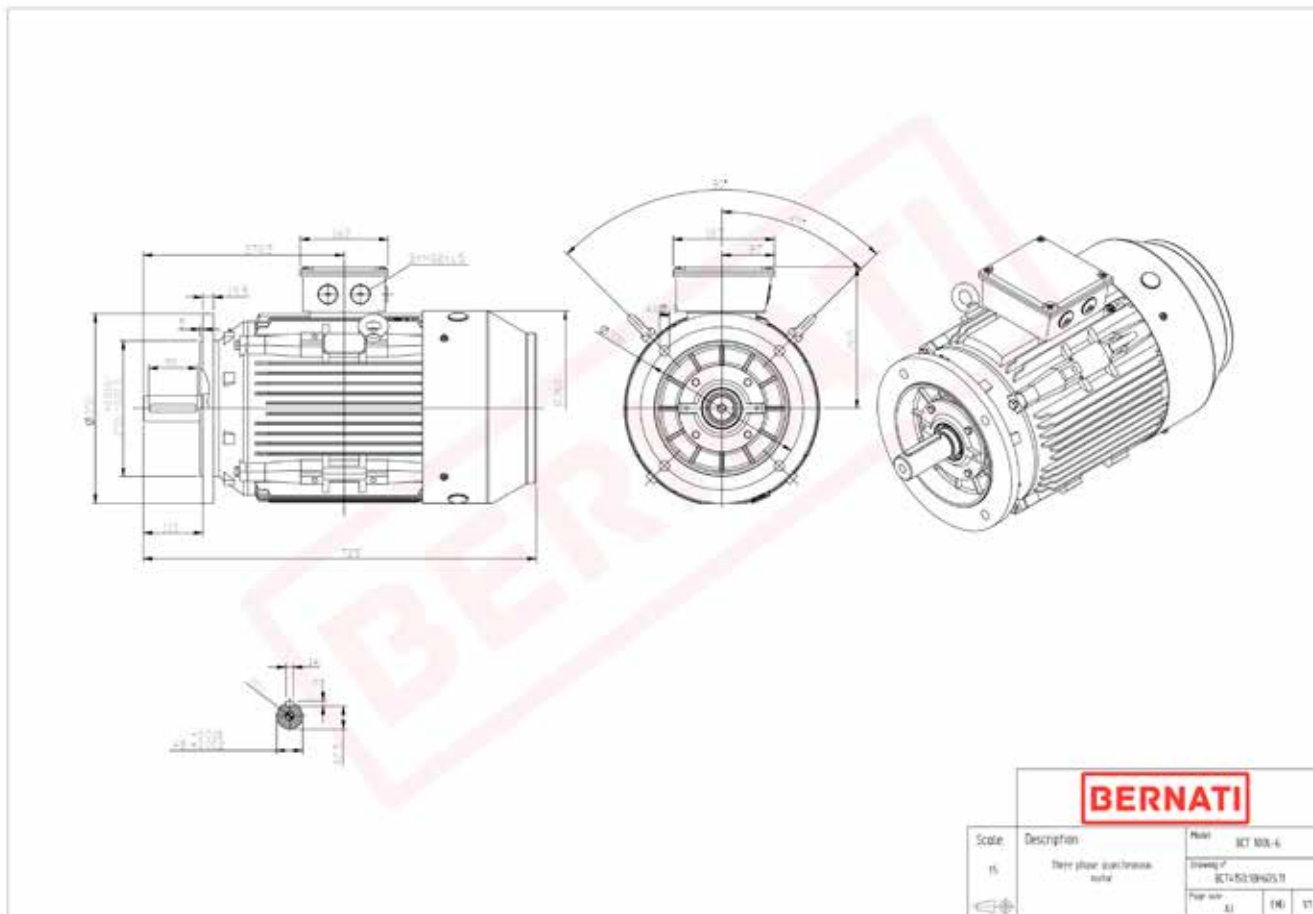

## BCT

Product Code	BCT4150.18H605.11
Motor Type/Frame	BCT 180L-6
Mounting	IM B5
Efficiency Class	IE4
Output Power (kW)	15.00
Speed (rpm)	975
Tension (V)	230/400
Frequency (Hz)	50
Current (A)	29.10
Power factor (Cos Ø)	0.80
Poles	6
Insulation Class	F
IP Class	IP55
50% Efficiency	92.8
75% Efficiency	93.2
100% Efficiency	92.9
Torque (Nm)	147.00
Tstart / Tnominal	2.00
Istart / Inominal	8.50
Tmax / Tnominal	2.10
Noise (dB)	73
PTC Thermistor	PTC 130
Weight (Kg)	226
DE Bearing	6311 C3
NDE Bearing	6311 C3