

# Technical Datasheet

**BERNATI**

BCT Series - Cast iron frame three phase low voltage electric motor

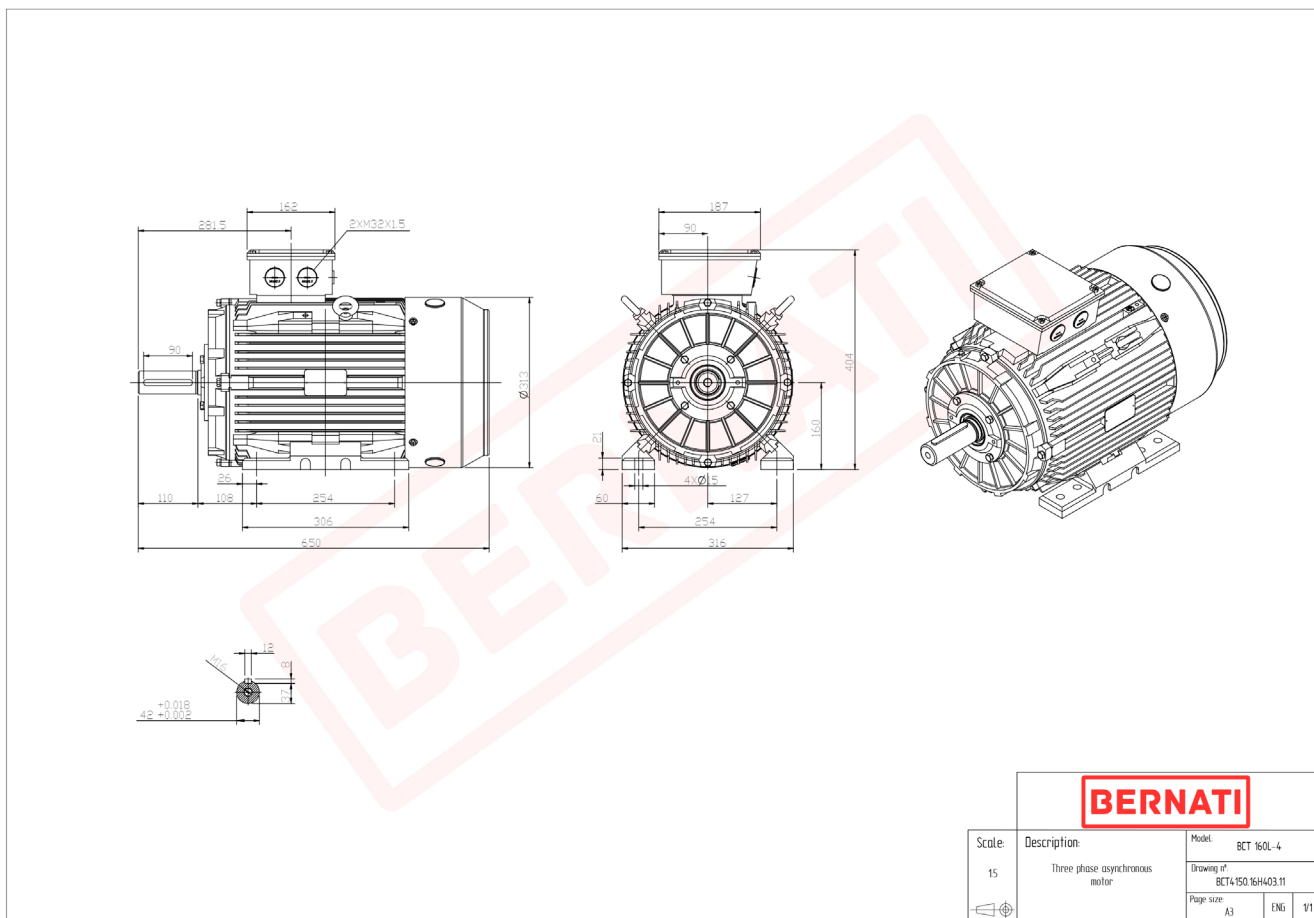

## BCT

Product Code	BCT4150.16H403.11
Motor Type/Frame	BCT 160L-4
Mounting	IM B3
Efficiency Class	IE4
Output Power (kW)	15.00
Speed (rpm)	1475
Tension (V)	230/400
Frequency (Hz)	50
Current (A)	27.50
Power factor (Cos Ø)	0.80
Poles	4
Insulation Class	F
IP Class	IP55
50% Efficiency	92.8
75% Efficiency	94.1
100% Efficiency	93.9
Torque (Nm)	97.20
Tstart / Tnominal	2.00
Istart / Inominal	9.50
Tmax / Tnominal	2.30
Noise (dB)	73
PTC Thermistor	PTC 130
Weight (Kg)	179
DE Bearing	6309 C3
NDE Bearing	6309 C3