

Technical Datasheet

BERNATI

BCT Series - Cast iron frame three phase low voltage electric motor

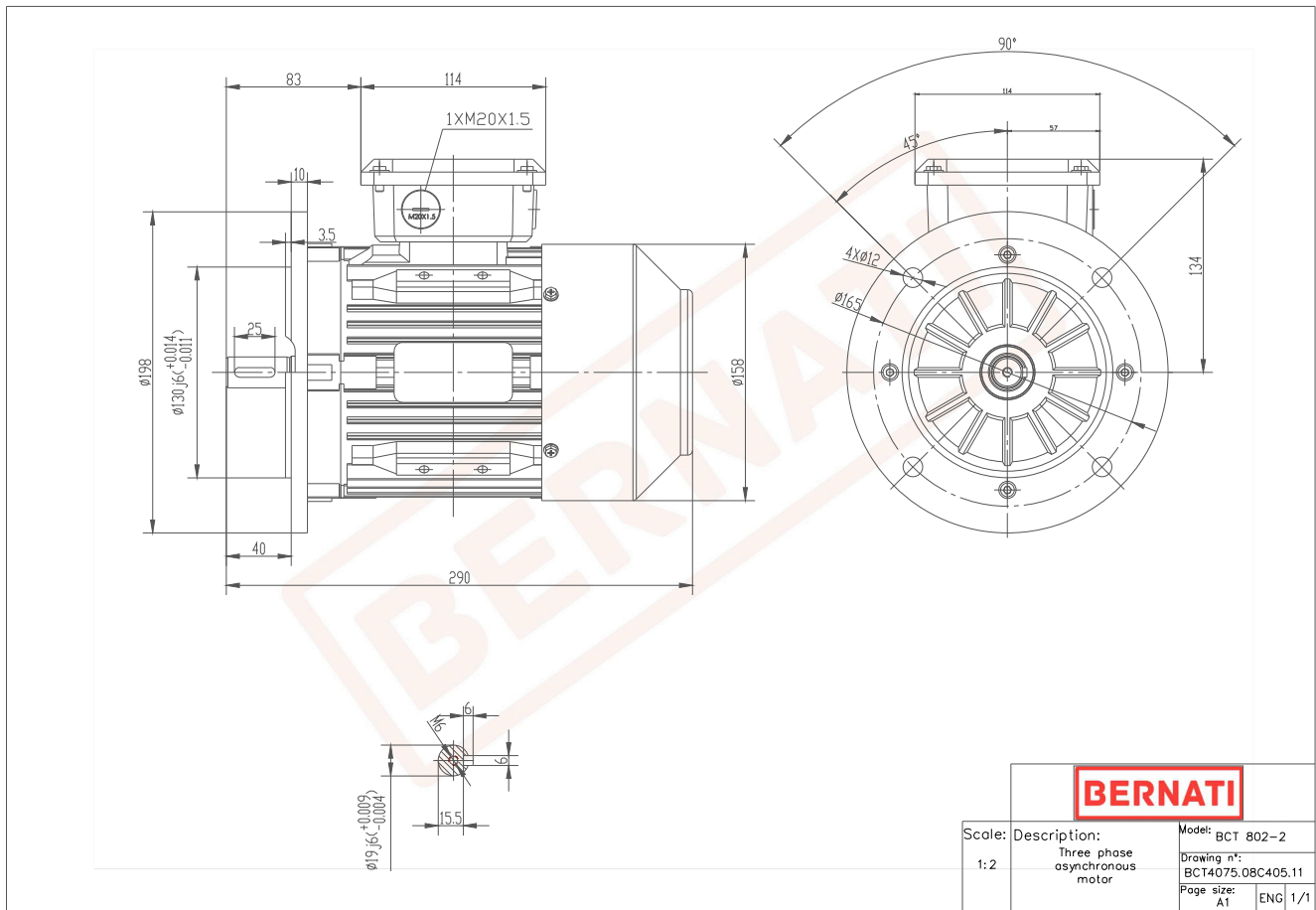

BCT

Product Code	BCT4075.08C405.11
Motor Type/Frame	BCT 802-4
Mounting	IM B5
Efficiency Class	IE4
Output Power (kW)	0.75
Speed (rpm)	2920
Tension (V)	230/400
Frequency (Hz)	50
Current (A)	1.70
Power factor (Cos Ø)	0.70
Poles	4
Insulation Class	F
IP Class	IP55
50% Efficiency	83.9
75% Efficiency	85.9
100% Efficiency	85.7
Torque (Nm)	5.00
Tstart / Tnominal	2.30
Istart / Inominal	8.50
Tmax / Tnominal	2.30
Noise (dB)	56
PTC Thermistor	PTC 130
Weight (Kg)	19
DE Bearing	6204 2RZ C3
NDE Bearing	6204 2RZ C3