

Technical Datasheet

BERNATI

BCT Series - Cast iron frame three phase low voltage electric motor

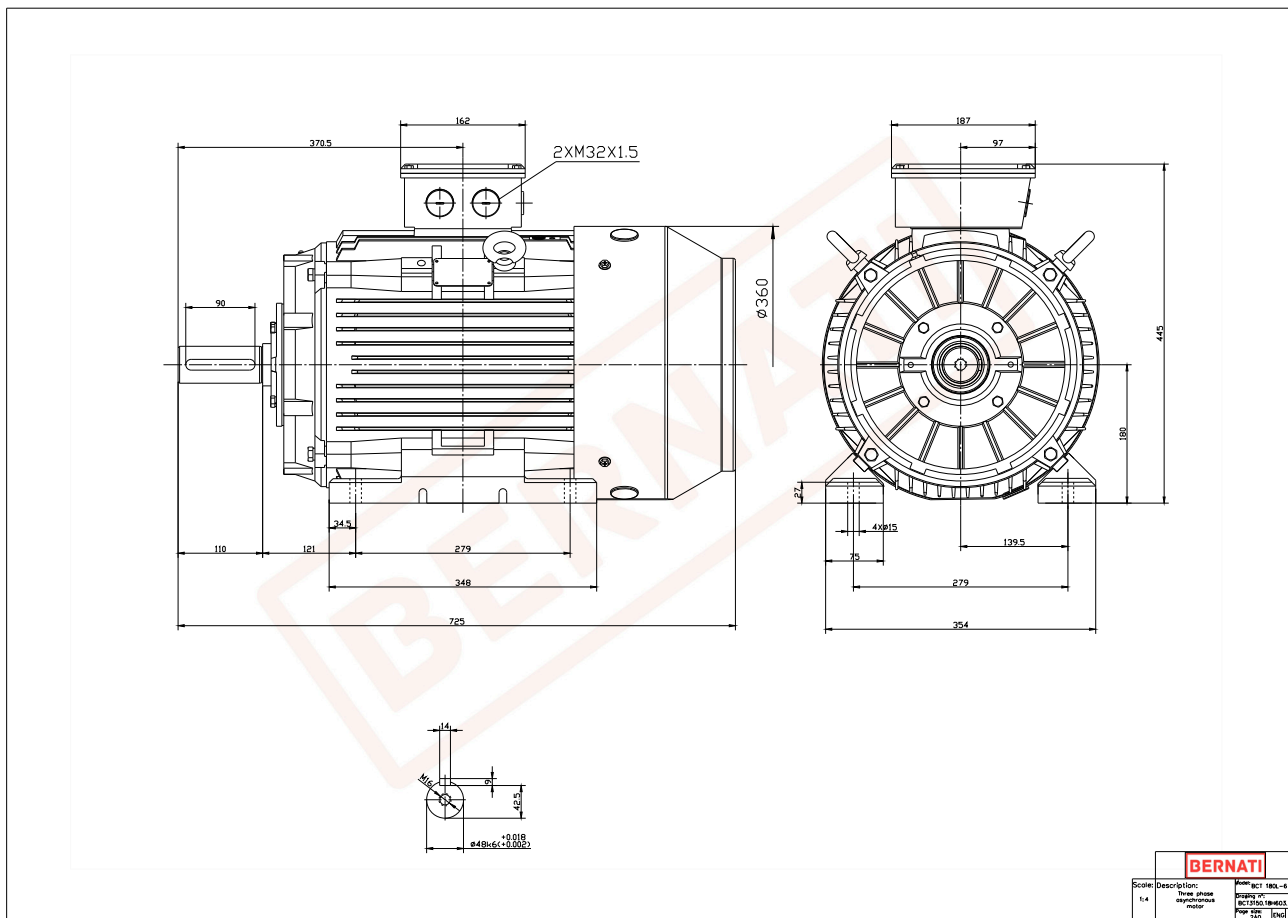

BCT

Product Code	BCT3150.18H603.11
Motor Type/Frame	BCT 180L-6
Mounting	IM B3
Efficiency Class	IE3
Output Power (kW)	15.00
Speed (rpm)	960
Tension (V)	230/400
Frequency (Hz)	50
Current (A)	30.10
Power factor (Cos Ø)	0.80
Poles	6
Insulation Class	F
IP Class	IP55
50% Efficiency	90.3
75% Efficiency	92.0
100% Efficiency	91.2
Torque (Nm)	149.20
Tstart / Tnominal	2.50
Istart / Inominal	8.00
Tmax / Tnominal	2.80
Noise (dB)	73
PTC Thermistor	PTC 130
Weight (Kg)	185
DE Bearing	6311 C3
NDE Bearing	6311 C3